

M2I Corporation

Industrial Monitor

MDP-SC

User Manual



Thank you for purchasing the industrial HMI touch panel series of M2I corporation.
Please read this manual carefully to know installing, wiring, operating this equipment for safe use of this product.





Index

Chapter 1 Safety Precautions.....	3
Chapter 2 Overview	5
2.1 Introduction of Products.....	5
2.2 Package Contents.....	5
2.3 Explanation of Model Name	5
Chapter 3 General Specifications	5
3.1 Power Specifications	5
3.2 Display Specifications	6
3.3 Touch Specifications.....	6
3.4 OSD Button (Screen Menu)	6
3.5 Speaker Specifications.....	6
3.6 USB Specifications.....	6
3.7 Environment Specifications.....	6
3.8 Structure Specifications	6
Chapter 4 Part Names and General Specifications.....	7
4.1 External Dimension	7
4.2 Part Names and Specifications	8
Chapter 5 External Device Interface	9
5.1 USB Specifications.....	9
5.2 HDMI Input Specifications.....	9
5.3 DP Input Specifications.....	9
Chapter 6 Installation	10
6.1 Installation Requirements	10
6.2 Installation Procedure.....	10
6.3 Front USB	12
6.4 Connecting with Outer Devices	12
Chapter 7 OSD Setup	13
7.1 Rear OSD Setup Buttons.....	13
7.2 OSD Settings.....	13
Chapter 8 Wiring	15
8.1 Power Cable Wiring.....	15
8.2 Ground Wiring	16
8.3 Fixing Communication Cable	17
Chapter 9 Maintenance	18
9.1 Cleaning the Display	18
9.2 Periodic Check Points.....	18
9.3 Problems with the Device.....	18
Chapter 10 Products and Warning Label.....	19







Chapter 1 Safety Precautions

■ Before using the product



To use the product safely and effectively, please read the contents of this manual thoroughly before use. Please keep to the safety precaution, for it is to prevent accidents and potential danger from occurring. Safety precaution is classified into 'Warning' and 'Caution' and their meanings are as follows. Also, the indicated illustrations on the product and in the manual have the following meanings.

 Warning	Violating the instruction may result in serious personal injury or death.
 Caution	Violating the instruction may result in slight personal injury or product damage.
	Be cautious, for danger may be present.
	Be cautious, for there is a possibility of an electric shock.





■ General Precautions Caution

-  Do not press the screen with a hard or sharp object (awl, screwdriver, pen) with too strong a force.
-  Do not use or store in an environment with high vibration.
-  Do not allow foreign objects such as water, liquids, or metal powders to enter the product. This may cause breakage or electric shock.
-  Use the radio or mobile phone at least 30cm away from the main unit.
-  Two or fewer bright spots may appear on the LCD screen, and certain areas may appear brighter, but this is not a defect in LCD characteristics.
-  Do not store or operate in direct sunlight. Direct sunlight can change the properties of the LCD.
-  During the product is stored in long-term without use, avoid a direct sunlight and keep dry condition.

■ Design Precautions Warning

-  For protecting whole control system from outer power input or malfunction of product, protection circuit must be installed outside of product.
-  Input/output signals or communication cables must have at least 100mm(3.94inch) distance from power cable or high-tension wire. Especially HDMI cables must be set apart from power cables.

■ Wiring Precautions Warning

-  Be sure the wiring is done correctly by checking the product's rated voltage and the terminal layout. Incorrect wiring could result in fire, damage or malfunctions.
-  Tighten the terminal screw with the specified torque. If the screws of terminal are loose, it could result in short circuit, fire, malfunctions.
-  FG Terminal must be used a dedicated ground. Not doing so could result in malfunctions.
-  a. Grounding should be the Class 3 grounding. The cable for grounding should be more than 2mm².
-  b. Grounding point be closed to the products and make short the distance to the ground cable if possible.

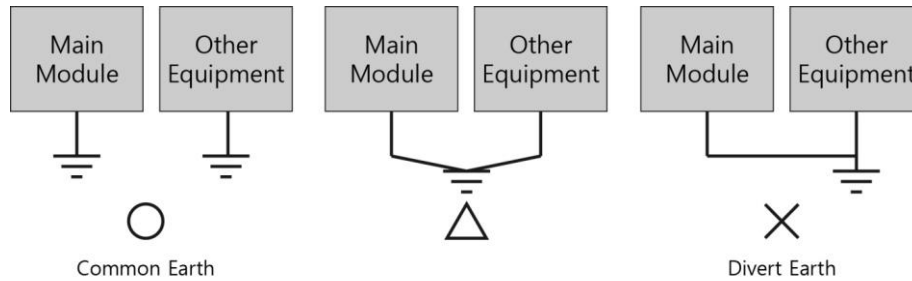





Fig. Grounding Example Diagram

■ Installation Precautions Caution

-  Do not install the location which exceeds allowed temperature. Product can be damaged or shorten the life. Especially Install environment as below should be avoided.
-  Do not Install product to the place which the ambient temperature is out of limits, from -10°C to 50°C or on the surface of control board which high pressure equipment is installed.
-  Do not install to the place where strong shock or vibration continuously have impacted on product.
-  Use the product under 2000M altitude.

■ Disposal Precautions Caution

When you dispose of product and battery, please treat it as industrial waste. It can create poisonous substances or explosion.

■ All field-wiring connections to this unit shall be from Limited Voltage / Limited Current, below 24Vdc isolated secondary source with an output fuse, or Class 2.

Chapter 2 Overview



2.1 Introduction of Products

This Industrial Monitor is required in an industrial field. It displays demanded screen features from multiple devices through HDMI connection, and a touch sensor can be connected to outer device by USB.

2.2 Package Contents

The components of the product are as follows.

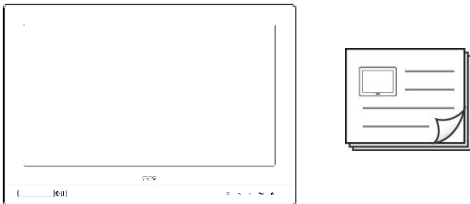
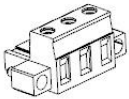
Before using the product, please check that all of the following components are included.

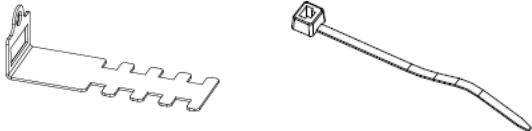
Item	Figure	Quantity
Product and User Manual		1 Each
Power Connector		1
Mounting Clamp		12
Cable Clamp and Cable Tie		HDMI: 1 DP: 1 USB: 1

2.3 Explanation of Model Name

Series	Display Input	Screen Size	Option and Resolution	Power	Explosion proof
MDP-	SC: 1 Port	12: 12.1" 15: 15.6" 19: 18.5"	00W: FHD, 1920 x 1080, Wide	A: AC D: DC	-Ex: Explosion proof or special model Blank: Non-explosion proof or general model

Chapter 3 General Specifications

3.1 Power Specifications

Normal Voltage	DC 24V, Class 2	
Input Voltage Range	DC 20~28V, Class 2	
Consumption Power	MDP-SC1200WD	40W
	MDP-SC1500WD	
	MDP-SC1900WD	
Voltage endurance	DC 24V, 10ms 이내	
Insulation Resistance	500V DC, 10MΩ	

3.2 Display Specifications

Display Color	16M Color
Backlight Type	LED
Backlight Life	Minimum 50,000 Hours
Resolution	Max. 1920 x 1080
Scaling	Up / Down Scaling Supported

3.3 Touch Specifications

Operating Method	Integrated, Capacitive Touch Sensor
Connection Method	USB Type A to Type A Cable

3.4 OSD Button (Screen Menu)

Operation Method	Integrated, Capacitive Touch Sensed Button
Buttons	Switch of Screen Inputs, Up/Down, Menu Call, Power

* OSD(On Screen Display): Screen Menu

3.5 Speaker Specifications

Output Power	1.2W + 1.2W
--------------	-------------

3.6 USB Specifications

USB	Front 1 port
Speed	USB 2.0

* If you want to use front USB port, rear USB port should be connected to USB Source.

3.7 Environment Specifications

Operation Temperature (°C)	-10 ~ +50
Storage Temperature (°C)	-20 ~ +60
Operation Humidity (%RH)	0 ~ 90 (No Dew)
Atmosphere	No corrosive gas
Vibration Endurance	Amplitude: $10 \leq F < 25$ Hz(2G) X,Y,Z each direction(for 30 minutes)
Noise Immunity	1000Vp-p(Pulse width 1 μ s)
Static Electricity Discharge	Connective discharge from EN61000-4-2: ± 4 kV
Shock Endurance	10G X,Y,Z each direction(for 3 times)
Surge Voltage	500V(Line-Line)
Ground Connection	Class 3(100 Ω or under)
Protection Classification	Front IP65

3.8 Structure Specifications

	MDP-SC1200WD	MDP-SC1500WD	MDP-SC1900WD
Weight (Kg)	TBD	TBD	4.7
Cooling System	Natural Air Circulation		
Case Material	Aluminum + Plastic		

Chapter 4 Part Names and General Specifications

4.1 External Dimension

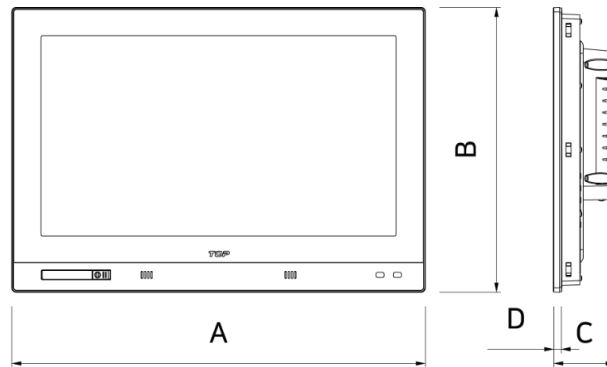
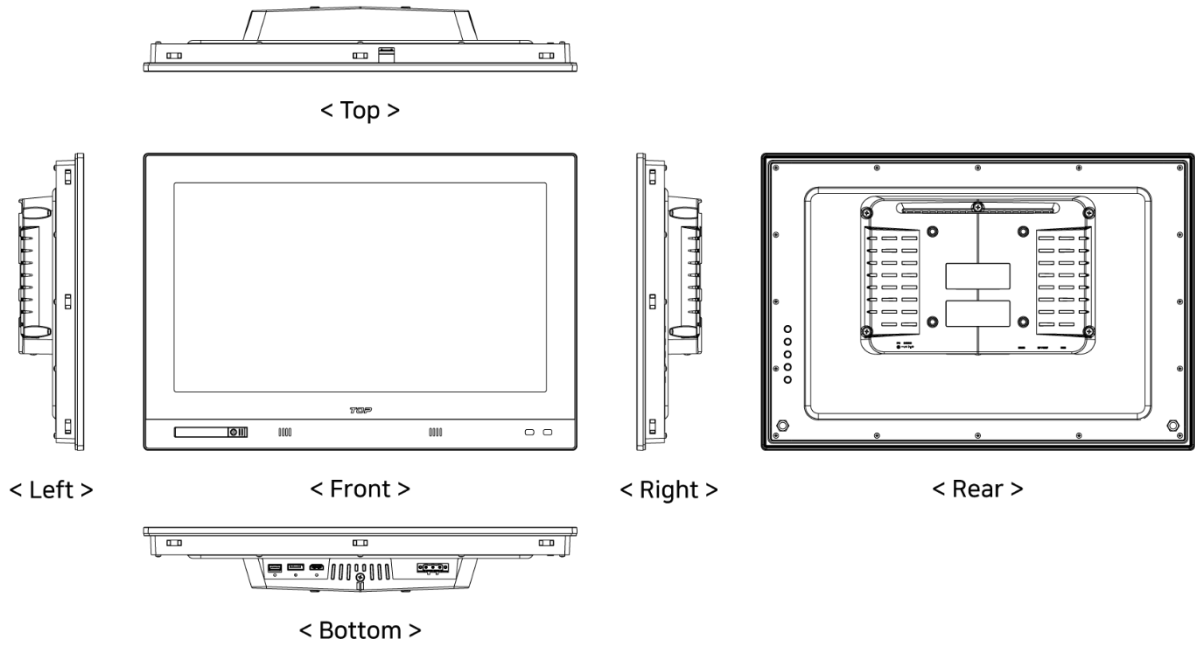

(mm)

Model	A	B	C	D
MDP-SC1200WD	321.4	252.4	67.5	7
MDP-SC1500WD	406.4	286.4	TBD	
MDP-SC1900WD	477.4	328.4	71.4	

4.2 Part Names and Specifications

4.2.1 Front

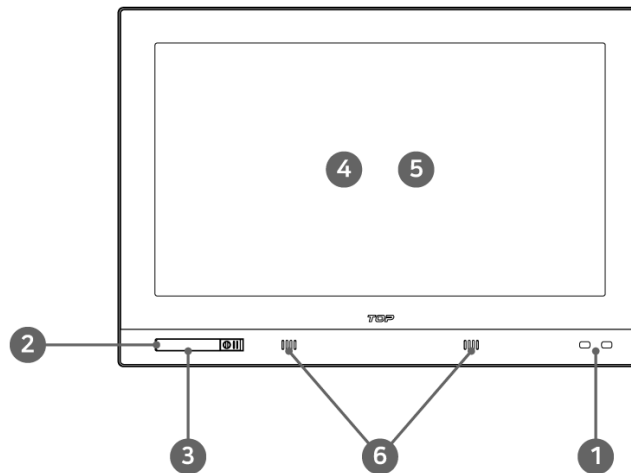

No.	Name	Description
①	LED	Status LED
②	USB HOST	USB Connector to use Mouse of Keyboard, Output Power 5V/0.5A
③	Front USB Cover	Front USB Cover
④	Touch Panel	Capacitive Touch Sensor
⑤	LCD	TFT 16M Color LCD
⑥	Speaker	1.2W output

4.2.2 Bottom

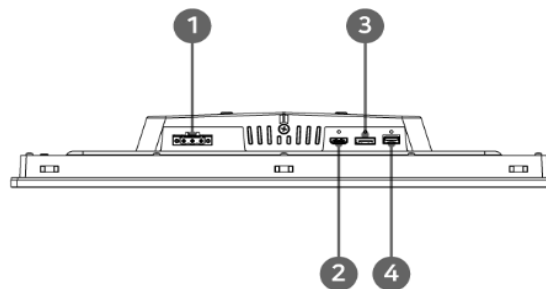

No.	Name	Type	Description
①	Power Terminal	TB 7.6mm 3P	Power Supply of Product
②	HDMI Port	Standard HDMI	HDMI Input
③	DP Port	DP	DP Input
④	USB Port	USB Type A	Connecting Outer Devices for Touch Sensor

Chapter 5 External Device Interface

In order for the main unit to communicate with an external device, it is necessary to connect the two devices by referring to the following.

5.1 USB Specifications

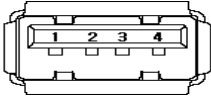
Type	Item	Specification
	USB Interface	USB 2.0
	Comm. Method	Control/Bulk
	Transfer Speed	Max. 480Mb/s
	Support Device	USB Storage, Mouse/Keyboard (FAT16/FAT32 File Format Available)
	Connector Type	USB Type A

5.2 HDMI Input Specifications

Type	Item	Specification
 HDMI (FEMALE)	HDMI	HDMI V1.4a
	Supported Resolution	Max. 1920 x 1080
	Connector Type	HDMI Type A

* This port is not working as output.

5.3 DP Input Specifications

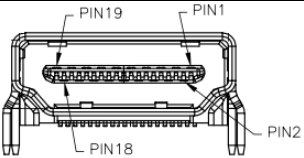
Type	Item	Specification
	DP	DP V1.1
	Supported Resolution	Max. 1920 x 1080
	Connector Type	Standard Display Port, 1 Port

* This port is not working as output.

Chapter 6 Installation Warning

6.1 Installation Requirements

- (1) It should be installed within -10 ~ 50°C and 10~80% relative-humidity, otherwise the screen may be changed or cause malfunction and damage.
- (2) Be sure that heat from surrounding equipment does not cause product to exceed its standard operating temperature.
- (3) In order to minimize external mechanical hazards, please control the mechanical hazards of the surrounding environment.

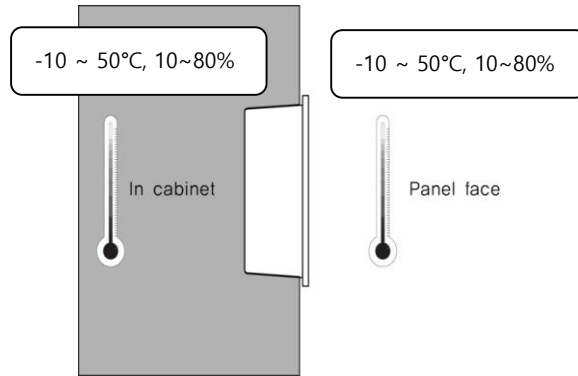

6.2 Installation Procedure

In order to install this product, please follow the following procedure.

6.2.1 Panel Cut

Make a panel cut which product is mounted and insert the product to the panel from the front side. Making the Panel Cut (Mounting Size) per each product as below Table, Before Installation.

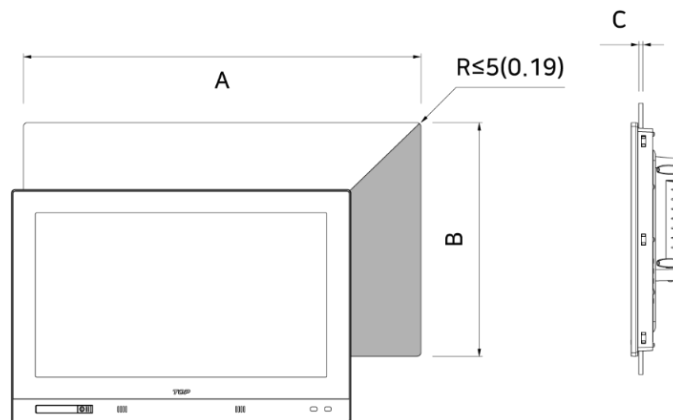

(mm)

Model	A	B	C
MDP-SC1200WD-Ex	307	238	1.6~5.0(+1.0/0)
MDP-SC1500WD-Ex	392	272	
MDP-SC1900WD-Ex	463(+0.5/0)	314(+0.5/0)	

6.2.2 Clamp Fixing  Warning

Install clamps with this product should be installed as follows to maintain the IP performance of the device.

(1) Insert the clamp into the slot of the product.

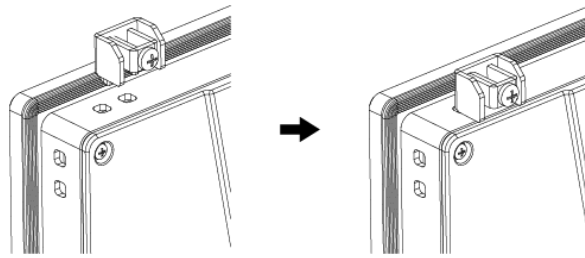

(2) Screw the unit into the panel cut with a screwdriver.

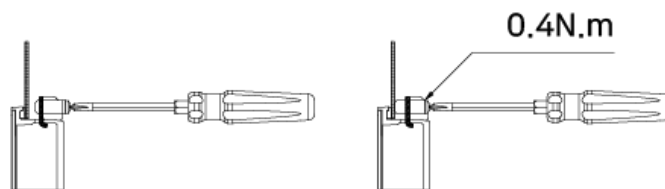

If the screw is over tightened, it may cause the front deformation, thus resulting the touch sensor can't work properly. Tighten the screws to a torque of 0.4N.m.

* Caution: If the torque of screwing is not 0.4N.m, IP specification will not be secured.  Warning

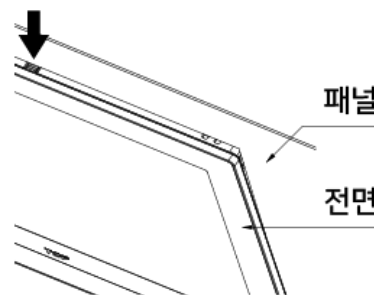

When you detach the product from a panel, please use tools like driver to push a lock part and detaching should be done slowly.

6.2.3 VESA Bracket Mount

Use M4 x 10mm screw to connect the monitor with VESA bracket.

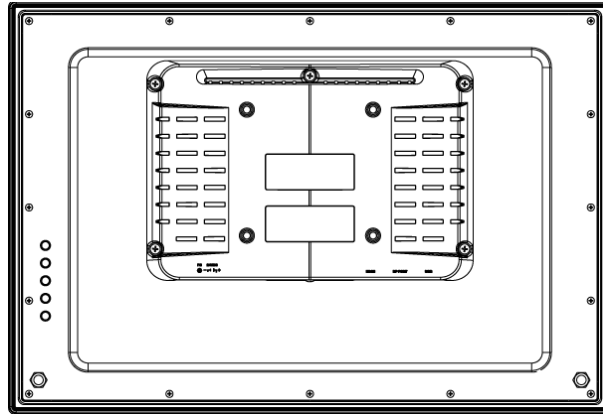

Please refer to user manual with VESA bracket.

- (1) Put the monitor on stable and flat ground with spread cotton or cushion.
- (2) Assemble a VESA bracket on rear side of the monitor.

6.3 Front USB

- (1) Slide the cover to open the USB Cover.
- (2) This cover can be locked and unlocked by making rotation of lock rotary switch.

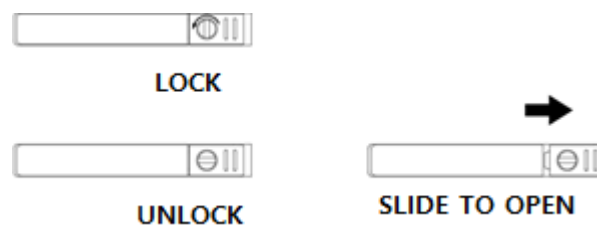

6.4 Connecting with Outer Devices



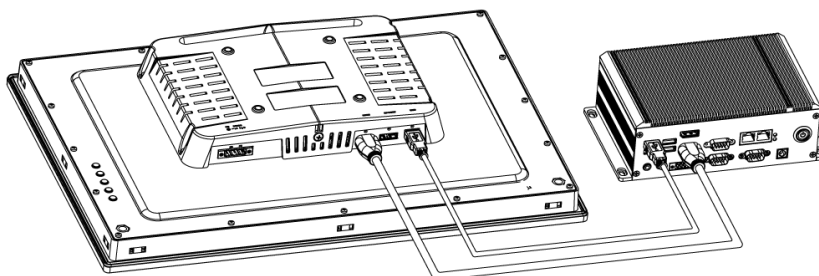

- (1) Connect the outer device to HDMI port or DP port on rear side of the product. Select HDMI or DP screen by screen change button on rear side.
- (2) Connect the cable to rear USB port for operation of touch sensor.
- (3) When keyboard and mouse are needed, they can be connected to front USB port.



Chapter 7 OSD Setup

7.1 Rear OSD Setup Buttons

Screen settings of this product can be done by rear OSD Menu Buttons.

No	Button Shape	Name	Description
1	 SELECT	Screen Change Switch	Screen change between HDMI and DP
2	 MENU	Menu Switch	Call display menu and select options
3	 UP	Menu Move Switch	Move the contents of menu to up or right side
4	 DOWN	Menu Move Switch	Move the contents of menu to down or left side
5	 POWER	Power Switch	Power ON/OFF

7.2 OSD Settings

OSD settings are configured as below.

7.2.1 Picture

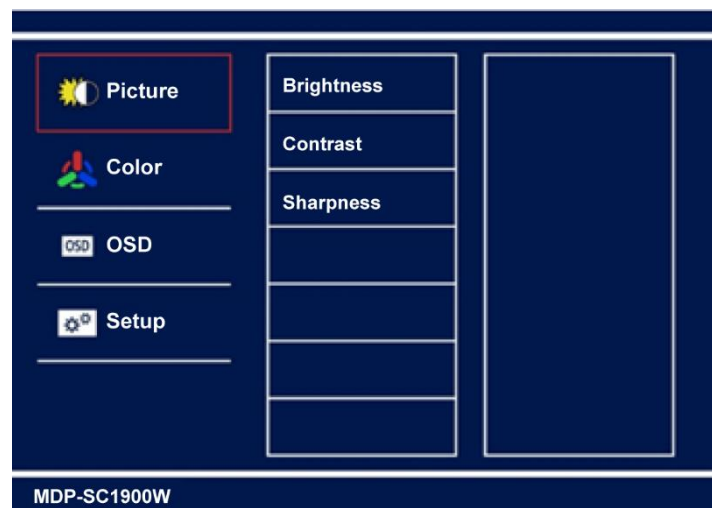

- Brightness [0 ~ 100]: Setting a brightness of screen.
- Contrast [0 ~ 100]: Setting a contrast of screen.
- Sharpness [0 ~ 4]: Setting a sharpness of screen.

7.2.2 Color

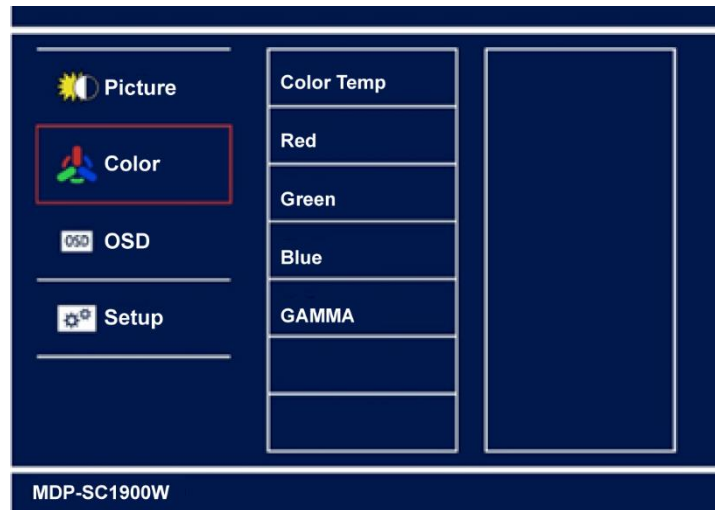

- Color Temp: Setting a temperature level of screen. (6500K, 7500K, 9300K, User Define)
- Red [0 ~ 100]: Setting a level of red color.
- Green [0 ~ 100]: Setting a level of green color.
- Blue [0 ~ 100]: Setting a level of blue color.
- GAMMA [Off, 1.8, 2.0, 2.2, 2.4]: Setting a GAMMA level of screen. Only selective in user define status.

7.2.3 OSD Settings

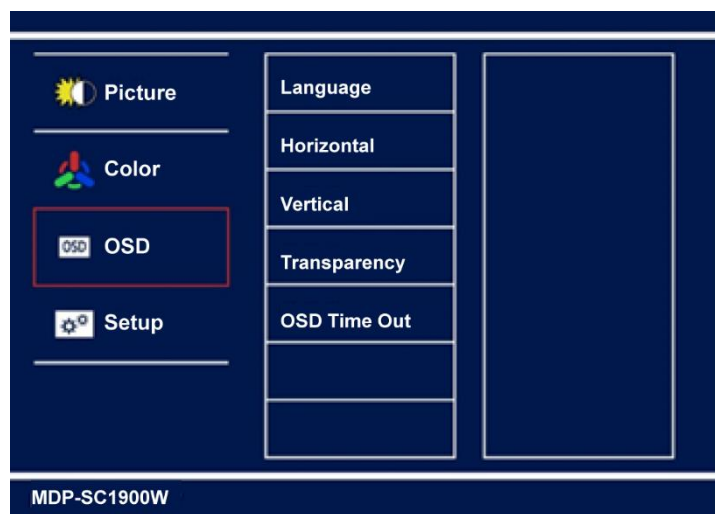

- Language [English, Korean]: Change the language of OSD
- Horizontal [0 ~ 100]: Adjust a horizontal point of OSD.
- Vertical [0 ~ 100]: Adjust a vertical point of OSD.
- Transparency [0 ~ 100]: Setting a transparency of OSD.
- OSD Time Out [0 ~ 100]: Setting a time of OSD OFF. Increasing 1 in setting make 0.5sec.

7.2.4 Setup

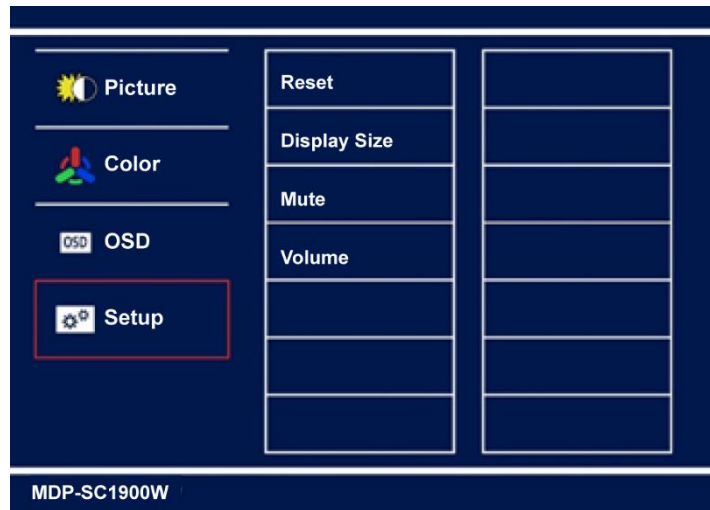

- Reset [Off, On]: Reset settings of OSD.
- Display Size [16:9, 4:3]: Force adjustment of screen ratio.
- Mute [Off, On]: Mute the audio or cancel the mute.
- Volume [0 ~ 100]: Setting the volume level.

Chapter 8 Wiring Warning

8.1 Power Cable Wiring

(1) The Power cable should have the following specification.

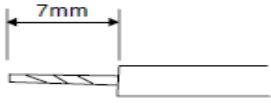
Power Cable Specification	0.75~2.5mm ² (18~12AWG)
F.G Cable Specification	2mm ² (14AWG) or more
Conductor Type	Simple or Standard Wire (Use Copper Wire)
Bolt tightening force	≥ 0.2N.m
Conductor Length	
Temperature rating of the field installed conductors	65°C or under

(2) Wiring of power cable and ground cable is as follows. Warning

Use the pin terminal to prevent the wear of cable and improve electronic transmission.

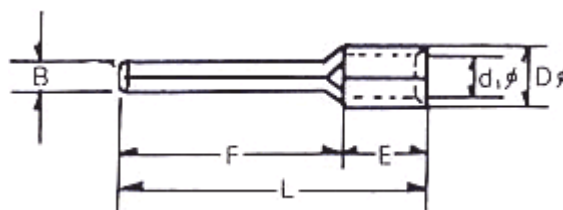

(mm)

B	L	F	E	D	d
1.8~2.0	22~18	12~14	5	3.3~3.8	2~2.5

(3) Wiring of power is as follows.

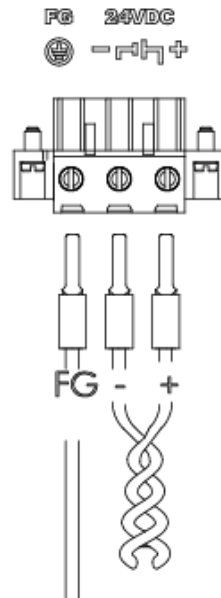

8.2 Ground Wiring

- (1) The product has enough anti-noise measure, so except that there are many noises. Specially, the ground is not needed. When doing ground, please refer to the followings.
- (2) The ground should be the exclusive ground. The ground should be type Class 3 ground. (Ground resistor is less than 100Ω.)
- (3) When you cannot do the exclusive ground, do common ground like below image.
- (4) Use the cable more than 2mm². Put the point of the ground near product and shorten ground line.

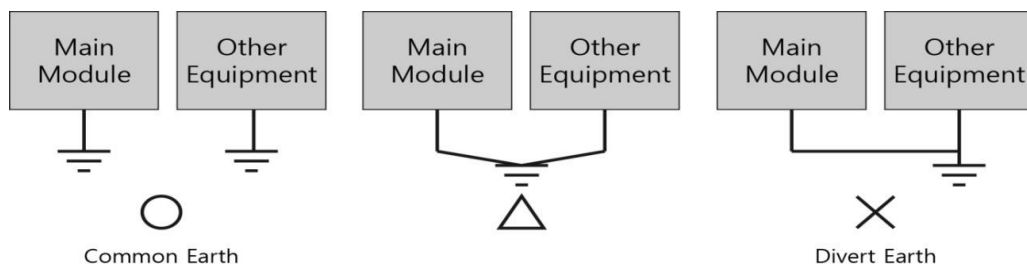
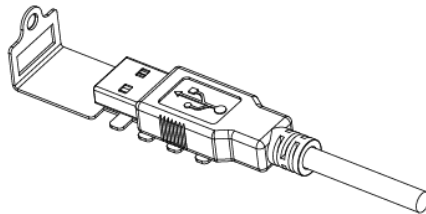

Fig. Grounding Example Diagram

8.3 Fixing Communication Cable

Caution: To prevent a disconnection or spark when USB cable gets away from the port, the cable must be fixed. User must be well-informed about below process.

(1) Insert a cable connector into a cable clamp as below image.



(2) Fix the cable connector inserted into the cable clamp as below image.

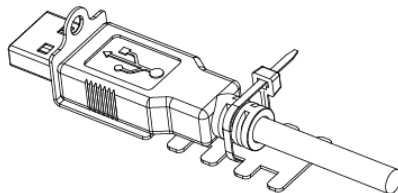

(3) Put fixed cable connector into USB port.

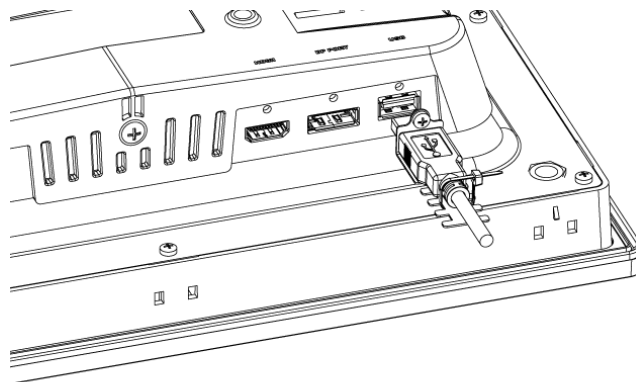

(4) Fix the cable clamp by a screw and check the fixing is normally done.

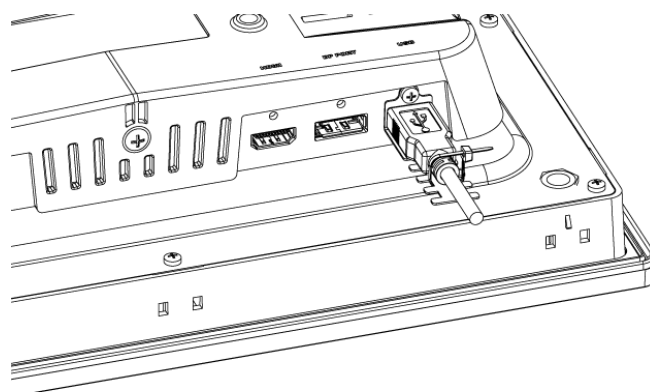

Chapter 9 Maintenance Warning

9.1 Cleaning the Display

When the surface or frame of the display become dirty, spray the cleaning solution onto a soft cloth and wipe the device. Do not spray the cleaning solution directly onto the device.

9.2 Periodic Check Points

Check the followings periodically for best condition of the device.

(1) Environment

- a. Is the operating temperature within the allowable range (-10°C~50°C)?
- b. Is the operating humidity within the allowable range (0%~90%RH)?
- c. Is the surrounding pollution no corrosive gas?

(2) Power

- a. Is the input power in right range?

(3) Related Items

- a. Check the guarantee duration of LCD Backlight by eye.
- b. Check the touch pad there is no damage, scratch or pollution by eye.

9.3 Problems with the Device Warning

- a. If there is a problem during operation, stop using it and contact the A/S department of M2I Corporation, which is indicated on the product label.
- b. Only the authorized worker from M2I Corporation can check and repair problems related to malfunction of the machine.
- c. If the problem cannot be solved at the installation site, the equipment can be collected and moved to M2I Corporation.
- d. The manufacturer, M2I Corporation, is not responsible for damage or malfunction of the equipment caused by the use conditions of the user beyond the installation and use standards described in the manual.
- e. If there is a high electromagnetic noise, put ferrite core on main power cable and field cable. The noise of power cable and communication cables can be high under the installation circumstances.
- f. Please put ferrite cores on each side's end when HDMI or USB is not working by noise.

Chapter 10 Products and Warning Label

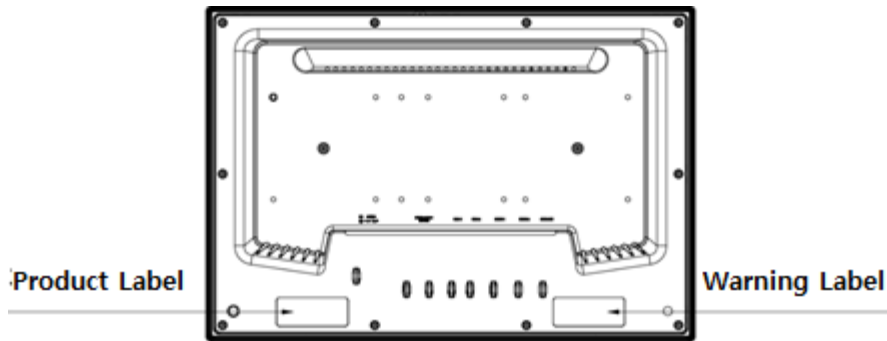

Manufacture (AS): M2I Corporation

11-35, Simin-daero 327beon-gil, Dongan-gu, Anyang-si, Gyeonggi-do 14055, Korea

Tel: 82-31-465-3366

Product Type: Industrial Monitor

Model Name and Power Specifications:

- MDP-SC1200WD: TBD
- MDP-SC1500WD: TBD
- MDP-SC1900WD: 20~28Vdc, 40W or less, Class 2 Power Only

Operation Temperature: $-10^{\circ}\text{C} \leq T_a \leq +50^{\circ}\text{C}$

KC Certificate No:

Model No:

Copyright: M2I Corporation 2024.10

www.m2i.co.kr

- Please read related contents in this manual when you use M2I product, and operate the product staying safe with appropriate handling.

- This manual should be stored in secured and appointed place so that it can be read in any needs.

User Guide

This product has Relevant Assessments for business environment. If this product is used in home environment, there can be an interference.