

**M2I Corporation**



# **Industrial HMI Touch Panel**

## **TOPRX-Ex Series**

### **Hardware Manual**

---

Thank you for purchasing the industrial HMI touch panel series of M2I corporation.

Please read this manual carefully to know installing, wiring, operating this equipment for safe use of this product.





## Contents

Chapter 1 Safety Precautions.....	3
Chapter 2 Overview .....	6
2.1 Introduction of Products.....	6
2.2 Package Contents.....	6
2.3 Explanation of Model name .....	7
2.4 Explosion-proof model name .....	7
Chapter 3 General Specifications .....	7
3.1 Electrical Specifications .....	7
3.2 Memory Specifications.....	7
3.3 Display Specifications .....	7
3.4 Touch Specifications.....	8
3.5 Environment Specifications .....	8
3.6 Structure Specifications .....	8
Chapter 4 Parts Identification and Functions.....	8
4.1 TOPRX10/12/15-Ex Series.....	8
Chapter 5 Interface .....	10
5.1 Serial Communication Specifications .....	10
5.2 Ethernet Interface .....	12
5.3 USB Interface .....	12
Chapter 6 Installation .....	13
6.1 Installation Requirements .....	13
6.2 Installation Procedure.....	13
Chapter 7 Wiring .....	15
7.1 Power wiring .....	15
7.2 Ground wiring .....	16
7.3 Cable Clamp installation .....	16
Chapter 8 Maintenance .....	17
8.1 Cleaning the Display .....	17
8.2 Periodic Check Points.....	17
8.3 Problems with the Device.....	18
8.4 Setting System Recovery Mode.....	18
Chapter 9 Products and Warning Label Location .....	18
Chapter 10 Products Label and Safety Certificates .....	19









## Chapter 1 Safety Precautions

### ■ Before using the product

To use the product safely and effectively, please read the contents of this manual thoroughly before use. Please keep to the safety precaution, for it is to prevent accidents and potential danger from occurring. Safety precaution is classified into 'Warning' and 'Caution' and their meanings are as follows. Also the indicated illustrations on the product and in the manual have the following meanings.







 <b>Warning</b>	Violating the instruction may result in serious personal injury or death.
 <b>Caution</b>	Violating the instruction may result in slight personal injury or product damage.
	Be cautious, for danger may be present.
	Be cautious, for there is a possibility of an electric shock.

### ■ Explosion Precautions **Warning**

-  THIS EQUIPMENT IS SUITABLE FOR USE IN CLASS I, DIVISION 2, GROUPS A, B, C AND D OR NON-HAZARDOUS LOCATIONS ONLY.
-  Do not open the product when explosive gas is around.
-  Do not open, maintain or service in an area where an explosive atmosphere.
-  Do not change SD Card when the power is connected to product.
-  All cables connected with the product should not be connected or disconnected when the power of product is on.
-  EXPLOSION HAZARD - DO NOT DISCONNECT OR CHANGE BATTERY UNLESS THE AREA IS KNOWN TO BE NON-HAZARDOUS. or equivalent.
-  RISQUE D'EXPLOSION. NE PAS BRANCHER NI DEBRANCHER SOUS TENSION.
-  LES BATTERIES NE DOIVENT ETRE REMPLACEES QUE DANS UN EMPLACEMENT EXEMPT DE CONCENTRATIONS
-  Touch the device after wiping the front panel with a damp cloth or wearing anti-static gloves, to avoid the electrostatic charges.

### ■ General Precautions **Caution**

Do not install the location which exceeds allowed temperature. Product can be damaged or shorten the life. Especially Install environment as below should be avoided.

-  Do not press the screen with a hard or sharp object (awl, screwdriver, pen) with too strong a force. It may cause malfunction of touch due to damage of the front sheet.
-  Do not use or store in an environment with high vibration.
-  Do not allow foreign objects such as water, liquids, or metal powders to enter the product. This may cause breakage or electric shock.
-  Use the radio or mobile phone at least 30cm away from the main unit.
-  Two or fewer bright spots may appear on the LCD screen, and certain areas may appear brighter, but this is not a defect in LCD characteristics.
-  Do not store or operate in direct sunlight. Direct sunlight can change the properties of the LCD.

■ Specific Conditions of Use

- ⊘ The equipment shall only be used in an area of at least pollution degree 2, as defined in IEC/EN 60664-1.
- ⊘ Equipment shall be installed in a back enclosure with tool removable door or cover that provides a degree of protection not less than IP 54 in accordance with IEC/EN 60079-0.
- ⊘ The equipment shall only be installed in locations where there is a low risk of mechanical damage.
- ⊘ External connections to the equipment, including the front USB port must not be inserted or removed unless either the area in which the equipment is installed is known to be non-hazardous, or the circuits connected have been de-energized.
- ⊘ External connections to the equipment must be secured using the mechanical securing devices provided adjacent to connection to prevent unintentional separation.
- ⊘ Provisions shall be made to prevent the rated voltage from being exceeded by transient disturbances of more than 140%.

■ Design Precautions  Warning

Install protection circuit on the outside of Products to protect the entire control system when external power supply or Products have problems.

- ⓘ As the malfunction & incorrect result of Products could damage the stability of the entire systems and human body, you must install damage preventing interlock circuit such as emergency stop, Protective circuits, positioning upper and lower limit switch and interlock for forward/reverse operation.
- ⓘ When computer or other controllers communicate and exchange data with products or change operation mode of products, set up protective sequence program in PC or Controller for protecting system from communication error.
- ⓘ The output signal or communication lines should be separated from the power line or high tension wire. They should be installed 100mm (3.94 Inch) or more from each other.

■ Wiring Precautions  Warning

- ⓘ Be sure the wiring is done correctly by checking the product's rated voltage and the terminal layout. Incorrect wiring could result in fire, damage or malfunctions.
  - ⓘ Tighten the terminal screw with the specified torque. If the screws of terminal are loose, it could result in short circuit, fire, malfunctions. FG Terminal must be used a dedicated ground. Not doing so could result in malfunctions.
  - ⓘ a. Grounding should be the Class 3 grounding. The cable for grounding should be more than 2mm<sup>2</sup>.
  - ⓘ b. grounding point be closed to the products and make short the distance to the ground cable if possible.
- Please see below.

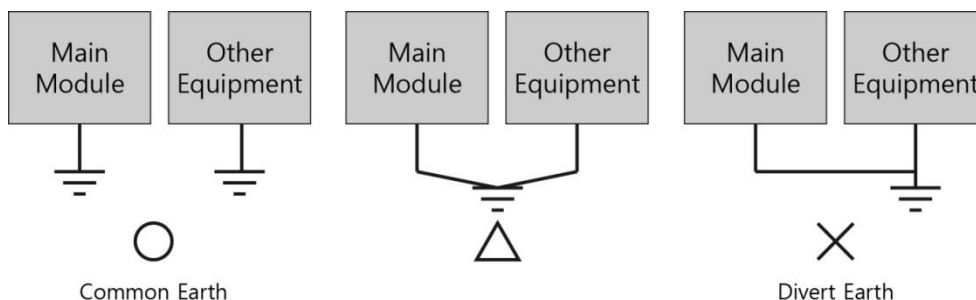





Fig. Grounding Example Diagram

■ Installation Precaution  **Caution**

Do not install the location which exceeds allowed temperature. Product can be damaged or shorten the life. Especially Install environment as below should be avoided.

-  Do not Install product to the place which the ambient temperature is out of limits, from -10°C to 50°C or on the surface of control board which high pressure equipment is installed.
-  Do not install to the place where strong shock or vibration continuously have impacted on product.
-  Use the product under 2000M altitude.
-  The length of the power cable must be no more than 3m (10 feet).

■ Disposal Precaution  **Caution**

When you dispose of product and battery, please treat it as industrial waste. It can create poisonous substances or explosion.

■ Battery Specification  **Caution**

Mounted on mainboard Model CTL920F Battery is not replaced by the user. If the battery has run out of service, please contact our Customer Support Center for replacement and inspection. ([www.m2i.co.kr](http://www.m2i.co.kr))

Item	Content
Voltage and capacity	DC 2.3V, 7.7mAh
Model name	CTL920F (lithium Rechargeable / non-exchangeable ), Panasonic
Lifetime	Permanent (In case of ambient temperature 25°C)
Battery Discharge	Last about 7 days After turn it off

\* Depending on the model specifications are subject to change.

■ All field-wiring connections to this unit shall be from Limited Voltage / Limited Current, below 20~28Vdc isolated secondary source with an output fuse, or Class 2 secondary circuits.

## Chapter 2 Overview







### 2.1 Introduction of Products

This industrial HMI touch panel is an industrial control device required in industrial field. It is a device based on RS-232C and RS-422/485, Ethernet which is used for the basic purpose of communication with another device(PLC).

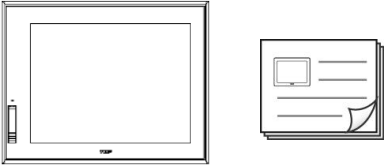
### 2.2 Package Contents

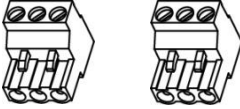
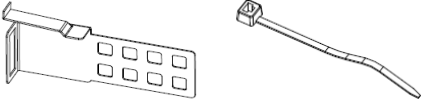
The components of the product are as follows.

Before using the product, please check that all of the following components are included.

Item	Figure	Quantity
Product and User Manual		1 each
Mounting Clamp		TOPRX10: 8 TOPRX12: 10 TOPRX15: 10
Power Connector and COM3 Communication Connector		1 each
USB Cable Clamp Cable Tie		1 each
Accessories (Sold separate)	 USB Memory  USB Cable  SD Card  Front Protect Sheet	User Options

## 2.3 Explanation of Model name

TOPRX	□□	□□	□	□	-	Ex		□□
Series	Display Size	Option	Resolution	power		Explosion proof	Blank	Reserve
	10: 10.4"	00: Standard	V: VGA (640*480)	A: AC		Ex: Explosion proof or special model		□□: Not related with explosion protection. This option does not affect safety. It consists of a alphanumeric code.
	12: 12.1"		S: SVGA (800*600)	D: DC		Blank: Non-explosion proof or general model		
	15: 15"		X: XGA (1024*768)					

## 2.4 Explosion-proof model name

Explosion-proof model name	Short name
TOPRX1000VD-Ex	TOPRX10-Ex
TOPRX1000SD-Ex	
TOPRX1200SD-Ex	TOPRX12-Ex
TOPRX1200XD-Ex	
TOPRX1500XD-Ex	TOPRX15-Ex

# Chapter 3 General Specifications

## 3.1 Electrical Specifications

Rated Voltage	DC 20 ~ 28V, Class 2
TOPRX10-Ex	12W or less
TOPRX12-Ex	15W or less
TOPRX15-Ex	18W or less
Voltage endurance	DC 24V, 10ms
Insulation Resistance	500V DC, 10MΩ

## 3.2 Memory Specifications

Screen Memory	128MB
Backup Memory	512KB: System buffer (10K Word), Including Alarm/Log/Recipe
Backup Period	Permanent
Real Time Clock	Built in(by Battery)

## 3.3 Display Specifications

Color	16M Colors
Brightness Level	10 Level(by software)
Backlight Type	LED
Backlight Life	50,000 hours
Display Font	MS Windows Vector font possible Image font
Front LED Indicate	Built in

### 3.4 Touch Specifications

Touch Type	Built-in, Analog resistive touch sensor
------------	---

### 3.5 Environment Specifications

Operation Temperature (°C)	-10 ~ +50
Storage Temperature (°C)	-20 ~ +60
Operation Humidity (%RH)	0 ~ 90 (No dew)
Atmosphere	No corrosive gas
Vibration Endurance	Amplitude: $10 \leq F < 25$ Hz(2G) X,Y,Z each direction(for 30 minutes)
Noise Immunity	1000Vp-p(Pulse width 1 $\mu$ s)
Static Electricity Discharge	Connective discharge from EN61000-4-2: $\pm 4$ kV
Shock Endurance	10G X,Y,Z each direction(for 3 times)
Ground Connection	Class 3(Under 100 $\Omega$ )
Protection Classification	Front IP54

### 3.6 Structure Specifications

	TOPRX10-Ex	TOPRX12-Ex	TOPRX15-Ex
Weight (Kg)	2.1	2.9	3.2
Cooling System	Natural air circulation		
Case Material	PC(Flameless)		

## Chapter 4 Parts Identification and Functions

### 4.1 TOPRX10/12/15-Ex Series

#### 4.1.1 Outline

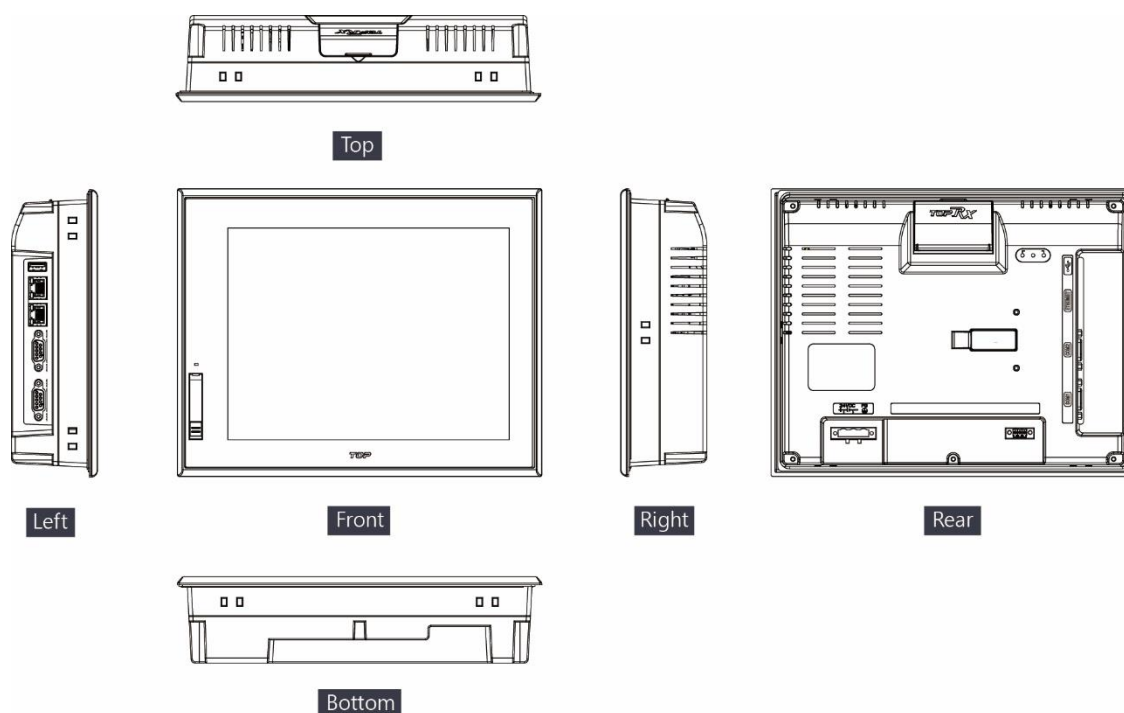



4.1.2 External Dimension

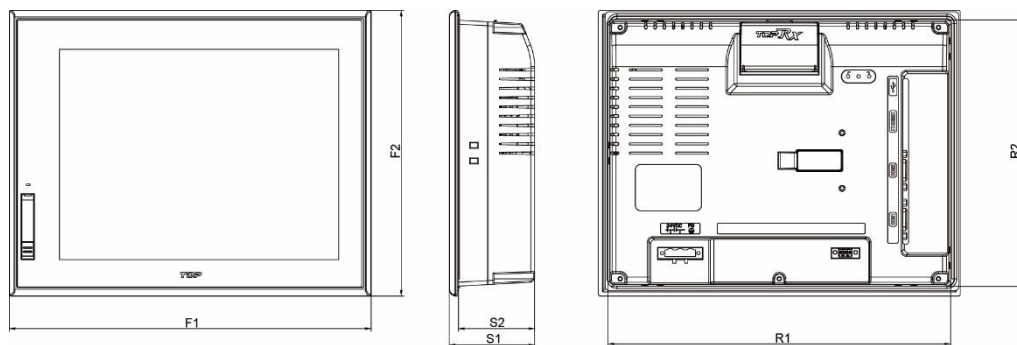

(mm)

Products	F1	F2	S1	S2	R1	R2
TOPRX10-Ex	274	216	64.7	58.7	259	201
TOPRX12-Ex	320	261	64.7	58.7	305	246
TOPRX15-Ex	369	300	67.2	61.2	354	285

4.1.3 Front Part Names and Specifications

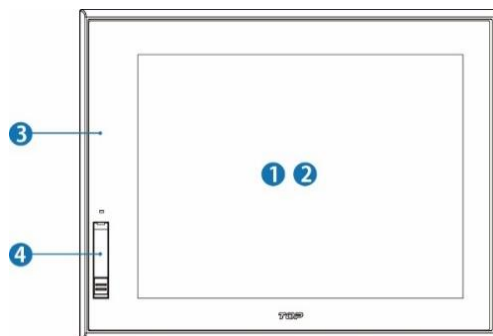

No.	Part	Description
①	LCD	TFT 16M Color LCD
②	Touch Panel	Analog Touch
③	Front Sheet	Front Cover Sheet for Damp Proof and Dust Proof
④	USB Port	USB Download/Upload Port

4.1.4 Rear Part Names and Specifications

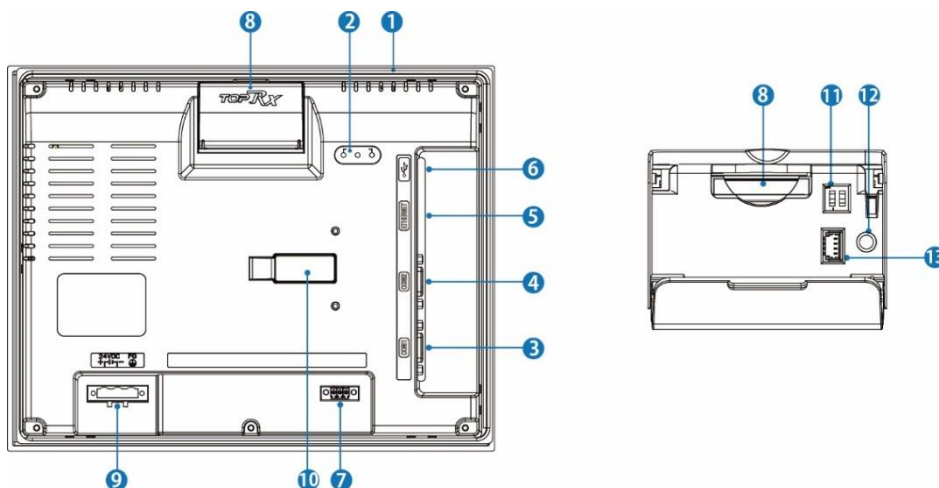

No.	Part	Form	Description
①	Rubber Packing	-	Silicone Gasket for Impact Buffering and IP Securing for Wall Mounting
②	Status LED	3 EA	Status of Power, Communication and CPU
③	COM1 Connector	DSUB9	RS-232C/422/485 Serial Comm. with PLC (Switchable the Comm. Via Software)
④	COM2 Connector	DSUB9	RS-232C/422/485 Serial Comm. with PLC (Switchable the Comm. Via Software)
⑤	ETHERNET Connector	RJ45	10BASE-T/100BASE-TX, Auto-MDIX
⑥	USB	Type A	USB Connectors for Storage Options
⑦	COM3 Connector	TB 3.5mm 3P	RS-485 Serial Comm. only
⑧	SD Card Cover	Plastic Cover	SD Card, Reset Switch, Mode Switch included
⑨	Power Input Terminal	TB 7.6mm,3P	Power Supply of Main Unit
⑩	Extension Module Connector	-	Not used
⑪	Mode Switch	DIP Switch 2Digit.	Set Up System Mode
⑫	Reset Switch	Tact Switch	System Reset Switch
⑬	Diagnose Connector	2mm 4P	Diagnose System (Manufacturer Only)

## Chapter 5 Interface

In order for the main unit to communicate with an external device, it is necessary to connect the two devices by referring to the following.

### 5.1 Serial Communication Specifications

#### 5.1.1 RS-232C

Items	Contents	
Protocol	Full Duplex	
Synch	Asynchronous	
Communication Distance	About 15m	
Type of Connection	1:1	
Control Code	ASCII Code or HEXA Code	
Transmission Speed	2400, 4800, 9600, 19200, 38400, 57600, 76800, 115200bps	
Data Type	Data Bit	7, 8bit
	Parity Bit	NONE, ODD, EVEN Parity
	Stop Bit	1, 2bit
Modular Jack	DSUB 9pin	

#### 5.1.2 RS-422/485

Items	Contents
Protocol	Full Duplex / Half Duplex
Synch	Asynchronous
Communication Distance	About 500m
Type of Connection	1:N (N ≤ 31)
Control Code	ASCII Code or HEXA Code

Transmission Speed		2400, 4800, 9600, 19200, 38400, 57600, 76800, 115200bps
Data Type	Data Bit	7, 8bit
	Parity Bit	NONE, ODD, EVEN Parity
	Stop Bit	1, 2bit
Modular Jack		DSUB 9pin

### 5.1.3 COM1 Connector pin number and Signal name

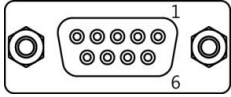
Type	Pin No.	Signal	Direction	Meaning
9Pin Female 	1	RDA(RD+)	Input	RS-422/485 Receive Data(+)
	2	RD(RxD)	Input	RS-232C Receive Data
	3	SD(TxD)	Output	RS-232C Send Data
	4	RDB(RD-)	Input	RS-422/485 Receive Data(-)
	5	SG	-	Signal Ground
	6	SDA(SD+)	Output	RS-422/485 Send Data(+)
	7	<sup>1)</sup> Power	-	+5V, 0.2A
	8	<sup>2)</sup> GND	-	Power Ground
	9	SDB(SD-)	Output	RS-422/485 Send Data(-)

\*<sup>1</sup>, \*<sup>2</sup>) If VCC is required for an external device, connect pin 7(+ 5.0V) and pin 8(\* 0.2A output).

### 5.1.4 COM2 Connector pin number and Signal name

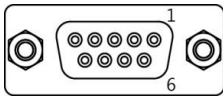
Type	Pin No.	Signal	Direction	Meaning
9Pin Female 	1	RDA(RD+)	Input	RS-422/485 Receive Data(+)
	2	RD(RxD)	Input	RS-232C Receive Data
	3	SD(TxD)	Output	RS-232C Send Data
	4	RDB(RD-)	Input	RS-422/485 Receive Data(-)
	5	SG	-	Signal Ground
	6	SDA(SD+)	Output	RS-422/485 Send Data(+)
	7	RTS	Output	RS-232C Request to Send
	8	CTS	Input	RS-232C Clear To Send
	9	SDB(SD-)	Output	RS-422/485 Send Data(-)

### 5.1.5 COM3 Connector pin number and Signal name

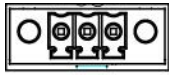
Type	Pin No.	Signal	Direction	Meaning
	1	D+	I/O	RS-485 Data(+)
	2	D-	I/O	RS-485 Data(-)
	3	SG	-	Signal Ground

\* Be sure to connect the RD and SD to the RS-232C communication line by crossing each other with a Twisted Pair Cable.

\* Please connect SG directly.

\* RS-422/485 communication line must use RDA and RDB as Twisted Pair Cable, SDA and SDB as Twisted Pair Cable.

\* Do not use shield wire of communication line as signal ground. It may cause communication failure.

## 5.2 Ethernet Interface

### 5.2.1 Ethernet

Item	Specification
Ethernet Method	IEEE802.3i/IEEE802.3u, 10BaseT / 100BaseT
Speed	10M / 100Mbps
Communication Method	Base Band
Switching Method	AUTO MDIX
Maximum Segment Length	100m (Hub between product)
Communication Cable	UTP (Unshielded Twisted Pair)
Modular Jack	RJ-45(2ch)

### 5.2.2 RJ-45 Pin Layout

Type	Pin No.	Color	Signal
	1	Orange/White	TD+
	2	Orange	TD-
	3	Green/White	RD+
	4	Blue	Not Available in 10BaseT
	5	Blue/White	Not Available in 10BaseT
	6	Green	RD-
	7	Brown/White	Not Available in 10BaseT
	8	Brown	Not Available in 10BaseT

\* When HUB is using, Straight cable should be used.

Ex) Straight Cable Wiring: Connect 1:1 according to the wiring diagram above.

\* In case of do not using HUB, do not use HUB, when it is connected directly, Cross Cable should be used.

Ex) Cross Cable Wiring: In the above wiring diagram, TD+ and RD+ are changed, and TD- and RD- are exchanged.

## 5.3 USB Interface

### 5.3.1 USB Host

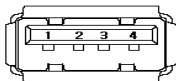
Type	Item	Specification
	USB Interface	EHCI/OHCI Specification Version 1.0, USB2.0/1.1 Available
	Communication Method	Control/Bulk
	Transfer Speed	Max. 480Mb/s
	Support Device	USB Storage (FAT16/FAT32 File Format Available)
	Connector Type	Type A

### 5.3.2 USB OTG

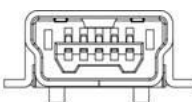
Type	Item	Specification
	USB Interface	USB 2.0
	Communication Method	Interrupt/Bulk/Isochronous
	Transfer Speed	480Mb/s
	Supporting OS	Windows 98SE/2000/XP/VISTA/7/10(32/64bit)
	Cable Length	M2I manufacturer's cable is recommended (3M), and 1.5M or less when purchased separately.

	Connect Type	MINI USB B, Female
	Connect Method	Connect Via USB Front

## Chapter 6 Installation

### 6.1 Installation Requirements

- (1) It should be installed within  $-10 \sim 50^{\circ}\text{C}$  and 10~80% relative-humidity, otherwise the screen may be changed or cause malfunction and damage.
- (2) Be sure that heat from surrounding equipment does not cause product to exceed its standard operating temperature.
- (3) In order to minimize external mechanical hazards, please control the mechanical hazards of the surrounding environment.

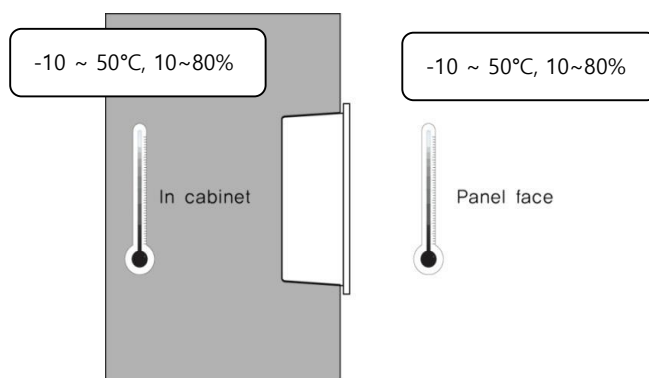

### 6.2 Installation Procedure Warning

#### 6.2.1 Panel Cut-out

Make a panel cut which product is mounted and insert the TOPRX to the panel from the front side. Making the Panel Cut (Mounting Size) per each TOPRX Series as below Table, Before Installation.

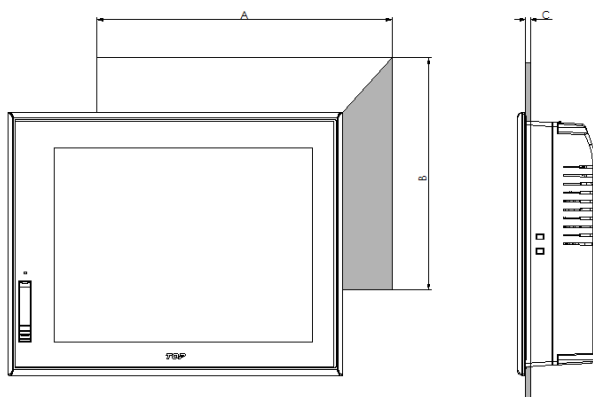

(mm)

Product	A	B	C
TOPRX10-Ex	260(+1.0/0)	202(+1.0/0)	1.0~5.0(+1.0/0)
TOPRX12-Ex	306(+1.0/0)	247(+1.0/0)	
TOPRX15-Ex	355(+1.0/0)	286(+1.0/0)	

6.2.2 Fixing  Warning

Installation methods should be following by using the supplied installation clamps.

(1) Insert the clamp into the slot of the product.

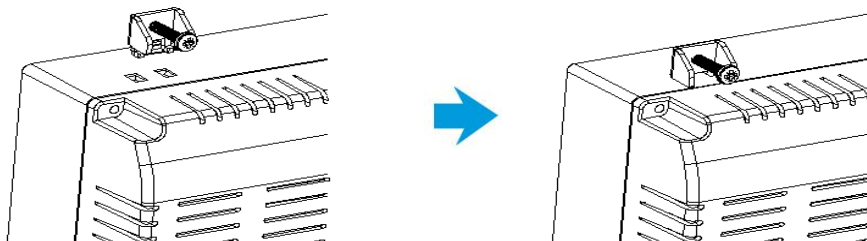

(2) Screw the unit into the panel cut with a screwdriver.

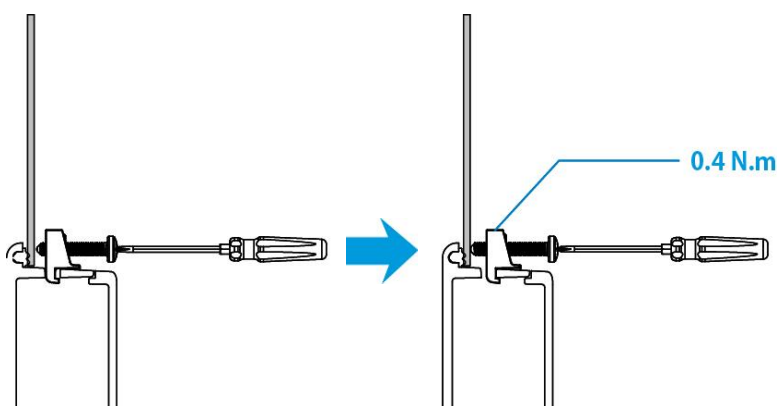

If the clamping screw below is over-tightened, the touch sensor may stop working or malfunction. Tighten to 0.4N.m screwdriver torque.

IP performance cannot be secured if the clamp is not tightened with a tightening force of 0.4N.m.  Warning

# Chapter 7 Wiring Warning

## 7.1 Power wiring

(1) The Power cable should have the following specification.

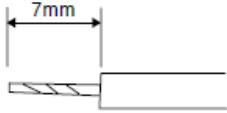
Power Cable Specification	0.75~2.5mm <sup>2</sup> (18~12AWG)
FG Cable Specification	Over 2mm <sup>2</sup> (14AWG)
Conductor type	Simple or Stranded wire
Bolt tightening force	≥ 0.2N.m  Warning
Conductor length	
Temperature rating of the field installed conductors	65°C Only

(2) The Power terminal should have the following specification.

The use of the Pin Terminal(ferrule) when installing the power supply and ground terminal is important for maintaining the performance of the device. Failure to install power and ground using the same Pin Terminal (ferrule) as below may cause explosion due to spark due to abnormal cable loss. Therefore, please be sure to familiarize yourself with how to use Pin Terminal(ferrule) below.

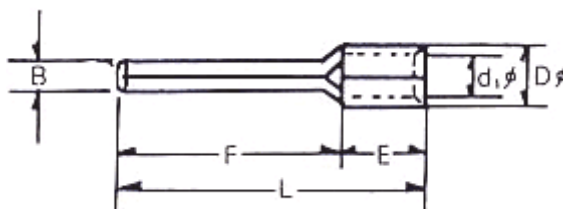

(mm)

B	L	F	E	D	d
1.8~2.0	22~18	12~14	5	3.3~3.8	2~2.5

(3) Wiring of power is as follows.  Warning

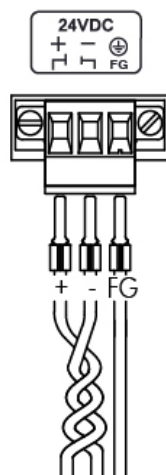

## 7.2 Ground wiring

- (1) The product has enough anti-noise measure, so except that there are many noises. Specially, the ground is not needed. When doing ground, please refer to the followings.
- (2) The ground should be the exclusive ground. The ground should be type class 3 ground (ground resistor is less than  $100\Omega$ ).
- (3) When not doing the exclusive ground, do common ground like figure B).
- (4) Use the cable more than  $2\text{mm}^2$ . Put the point of the ground near product and shorten Ground line.

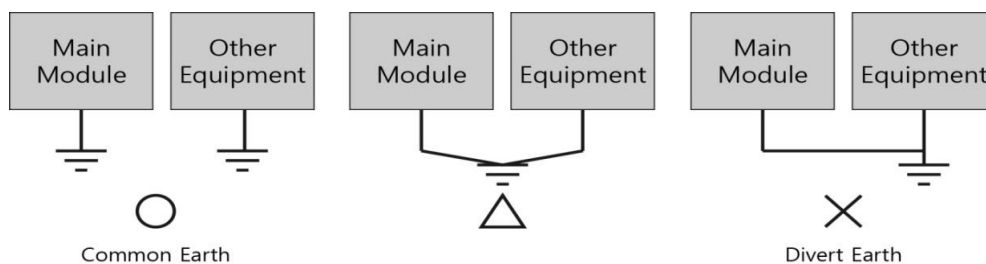

Fig. Grounding Example Diagram

## 7.3 Cable Clamp installation Warning

If you use an extension cable on the USB terminal block, install the cable clamp to prevent the USB connection from being disconnected or sparking because the cable is disconnected.

The user should familiarize themselves with the following methods of using the clamp.

Do not use USB in explosive circumstances. There can be an explosion during operation.

- (1) Place cable clamp at the screw hole on Rear of Display Module and turn the screw to fix it.

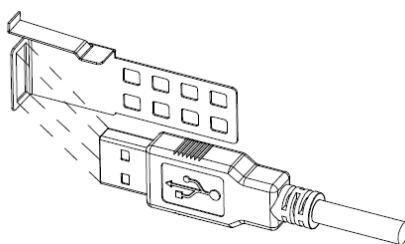

- (2) Fix the USB cable connector inserted into the cable clamp as shown in the figure.

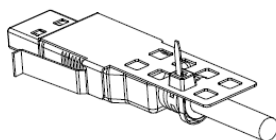



(3) Insert the USB cable connector fixed to the cable clamp into the USB terminal block while pressing the marked area as shown in the figure.

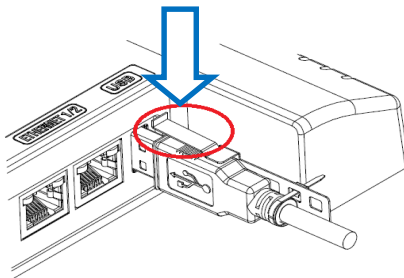

(4) Check that the cable clamp is fixed as shown in the figure.

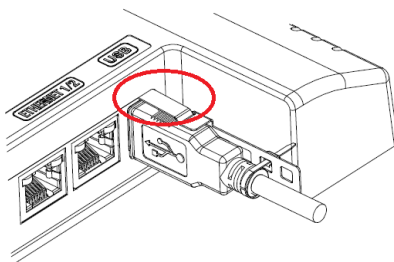

## Chapter 8 Maintenance

### 8.1 Cleaning the Display

When the surface or frame of the display become dirty, spray the cleaning solution onto a soft cloth and wipe the device. Do not spray the cleaning solution directly onto the device.

### 8.2 Periodic Check Points

Check the followings periodically for best condition of the device.

#### (1) Environment

- a. Is the operating temperature within the allowable range (-10°C~50°C)?
- b. Is the operating humidity within the allowable range (10%~80% RH)?
- c. Is the Surrounding pollution no corrosive gas?

#### (2) Power

- a. Is the input voltage within the change range?

#### (3) Related Items

- a. Check the guarantee duration of LCD Backlight by eye.
- b. Check the touch pad there is no damage, scratch or pollution by eye.

### 8.3 Problems with the Device

- (1) If there is a problem during operation, stop using it and contact the A/S department of M2I Corporation, which is indicated on the product label.
- (2) Only the authorized worker from M2I Corporation can check and repair problems related to malfunction of the machine.
- (3) If the problem cannot be solved at the installation site, the equipment can be collected and moved to M2I Corporation.
- (4) The manufacturer, M2I Corporation, is not responsible for damage or malfunction of the equipment caused by the use conditions of the user beyond the installation and use standards described in the manual.

### 8.4 Setting System Recovery Mode



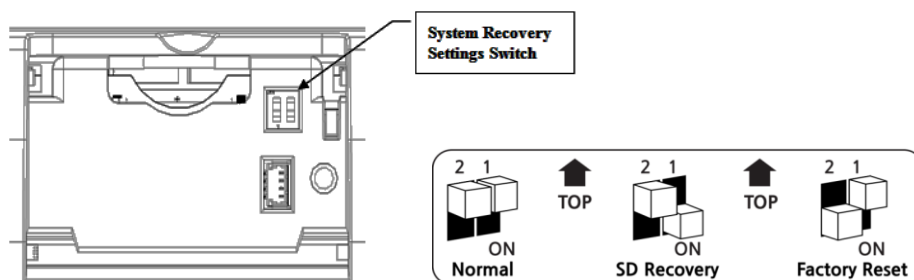

- (1) If the system fails to boot normally due to a problem during operation, the built-in recovery function can be used to maintain the factory default state. Please note that the built-in project will be deleted when using the recovery mode.
- (2) After opening the rear cover, you can adjust the setting switch. Keep the "Normal" state when booting normally. If the system is recovering, turn off the power and set it to "Factory Reset".
- (3) When the recovery is completed, the buzzer sounds, then turn off the power and reset to "Normal" state.

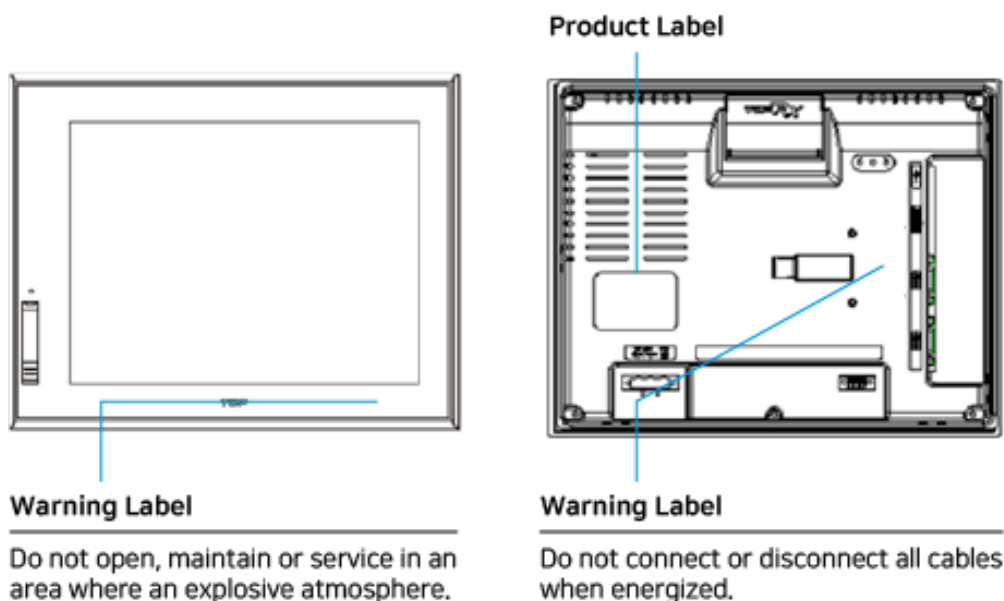

## Chapter 9 Products and Warning Label Location

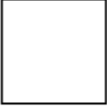

# Chapter 10 Products Label and Safety Certificates

Manufacture (AS)	→	<b>M2I Corporation</b> 工业操作终端	Service & Support www.m2i.co.kr
*Model Name	→	TOPRX1□□□□□-Ex	M2I Bldg, Simin-daero 327, Anyang-si, 14055
**Rated Voltage	→	IN(输入): 20~28V  class 2, □□W	Made In Korea
Battery Specification	→	Inside Cell(内部电池): CTL920F	韩国制造
Operation Temp.	→	S / N (产品系列号): 00000 Tamb (使用温度): -10°C ≤ Ta ≤ +50°C	0.0.0 <input type="text"/>
WARNING	→	Ingress Protection(入口保护): IP54(Front/正面), 2X(Rear/背部) WARNING - POTENTIAL ELECTROSTATIC CHARGING HAZARD ⚠ SEE INSTRUCTIONS ⚠ If you need change the inside battery please contact the A/S center ⚠ For use on a flat surface of a Type 1 Enclosure	
Certificates & Protection	→	 E526919 PROG. CNTLR. Class I Division 2 Group A, B, C, D T6 Haz. Loc  Ex nA IIC T6 XXXX.XXXXXXXX  IIG Ex ic ec IIC T6 Gc UL 22 ATEX 2792X IECEx UL 22.0050X  Ex ec IIC T6 Gc 2021322309003630	

\*Model Name: TOPRX□□□□□-Ex

\*\*Rated Voltage:

- TOPRX10-Ex 20~28Vdc, 12W or less, Class 2
- TOPRX12-Ex 20~28Vdc, 15W or less, Class 2
- TOPRX15-Ex 20~28Vdc, 18W or less, Class 2

Copyright: M2I Corporation 2024.06

[www.m2i.co.kr](http://www.m2i.co.kr)

Doc. No.: TOPRX-D0003 Rev.0

- When using M2I equipment, thoroughly read this datasheet and associated manuals introduced in this datasheet, also pay careful attention to safety and handle the module properly.
- Store this datasheet in a safe place so that you can take it out read it whenever necessary.