



M2I Corporation

Industrial HMI Touch Panel

TOPRT-Ex Series

Hardware Manual

Thank you for purchasing the industrial HMI touch panel series of M2I corporation.

Please read this manual carefully to know installing, wiring, operating this equipment for safe use of this product.





Index

Index	2
Chapter 1 Safety Precautions.....	3
Chapter 2 Overview	5
2.1 Introduction of Products.....	5
2.2 Package Contents.....	5
2.3 Explanation of Model name.....	6
Chapter 3 General Specifications	7
3.1 Electrical Specifications.....	7
3.2 Display Specifications	7
3.3 Touch Specifications.....	7
3.4 Sub Function Specifications (*Premium models only)	7
3.5 Memory Specifications.....	7
3.6 Environment Specifications.....	8
3.7 Structure Specifications	8
Chapter 4 Part Names and General Specifications.....	8
4.1 TOPRT1210SD-Ex.....	8
4.2 TOPRT1230XD-Ex / TOPRT1240XD-Ex.....	10
4.3 TOPRT12-Ex Series-Rear Part Names and Specifications	11
4.4 TOPRT12-Ex Series- Side Part Names and Specifications.....	11
4.5 TOPRT12-Ex Series- Top Part Names and Specifications.....	12
4.6 TOPRT12-Ex Series- Bottom Part Names and Specifications	12
Chapter 5 External Device Interface	12
5.1 Serial Interface	12
5.2 Ethernet Communication Specifications	14
5.3 USB Interface	15
Chapter 6 Installation	16
6.1 Installation Requirement.....	16
6.2 TOPRP Assemble.....	16
6.3 Installation Procedure.....	17
6.4 Front USB	19
Chapter 7 Wiring	19
7.1 Power wiring	19
7.2 Ground wiring	20
7.3 Cable Clamp Installation	21
Chapter 8 Maintenance	22
8.1 Cleaning the Display	22
8.2 Periodic Check Points.....	22
8.3 Problems with the Device.....	22
8.4 Setting System Recovery Mode.....	22
Chapter 9 Product and Warning Label	23
Chapter 10 Product Label.....	24

Chapter 1 Safety Precautions









■ Before using the product

To use the product safely and effectively, please read the contents of this manual thoroughly before use. Please keep to the safety precaution, for it is to prevent accidents and potential danger from occurring. Safety precaution is classified into 'Warning' and 'Caution' and their meanings are as follows. Also the indicated illustrations on the product and in the manual have the following meanings.







 Warning	Violating the instruction may result in serious personal injury or death.
 Caution	Violating the instruction may result in slight personal injury or product damage.
	Be cautious, for danger may be present.
	Be cautious, for there is a possibility of an electric shock.

■ Explosion proof(Ex) Precautions **Warning**



THIS EQUIPMENT IS SUITABLE FOR USE IN CLASS I, DIVISION 2, GROUPS A, B, C AND D OR NON-HAZARDOUS LOCATIONS ONLY.

-  Do not open the product when explosive gas is around.
-  Do not open, maintain or service in an area where an explosive atmosphere.
-  Do not change SD Card when the power is connected to product.
-  All cables connected with the product should not be connected or disconnected when the power of product is on.
-  EXPLOSION HAZARD - DO NOT DISCONNECT OR CHANGE BATTERY UNLESS THE AREA IS KNOWN TO BE NON-HAZARDOUS. or equivalent.
-  RISQUE D'EXPLOSION. NE PAS BRANCHER NI DEBRANCHER SOUS TENSION.
-  LES BATTERIES NE DOIVENT ETRE REMPLACEES QUE DANS UN EMPLACEMENT EXEMPT DE CONCENTRATIONS
-  Touch the device after wiping the front panel with a damp cloth or wearing anti-static gloves, to avoid the electrostatic charges.

■ General Precautions **Caution**

-  Do not press the screen with a hard or sharp object (awl, screwdriver, pen) with too strong a force. It may cause malfunction of touch due to damage of the front sheet.
-  Do not use or store in an environment with high vibration.
-  Do not allow foreign objects such as water, liquids, or metal powders to enter the product. This may cause breakage or electric shock.
-  Use the radio or mobile phone at least 30cm away from the main unit.
-  Two or fewer bright spots may appear on the LCD screen, and certain areas may appear brighter, but this is not a defect in LCD characteristics.
-  Do not store or operate in direct sunlight. Direct sunlight can change the properties of the LCD.

■ Specific Conditions of Use

-  The equipment shall only be used in an area of at least pollution degree 2, as defined in IEC/EN 60664-1.
-  Equipment shall be installed in a back enclosure with tool removable door or cover that provides

a degree of protection not less than IP54 in accordance with IEC/EN 60079-0.

- ⊘ The equipment shall only be installed in locations where there is a low risk of mechanical damage.
- ⊘ External connections to the equipment, including the front USB port must not be inserted or removed unless either the area in which the equipment is installed is known to be non-hazardous, or the circuits connected have been de-energized.
- ⊘ External connections to the equipment must be secured using the mechanical securing devices provided adjacent to connection to prevent unintentional separation.
- ⊘ Provisions shall be made to prevent the rated voltage from being exceeded by transient disturbances of more than 140%.

■ Design Precautions Warning

Install protection circuit on the outside of Products to protect the entire control system when external power supply or Products have problems.

- ⚠ As the malfunction & incorrect result of Products could damage the stability of the entire systems and human body, you must install damage preventing interlock circuit such as emergency stop, Protective circuits, positioning upper and lower limit switch and interlock for forward/reverse operation.
- ⚠ When a computer or other controllers communicate and exchange data with products or change operation mode of products, set up protective sequence program in PC or Controller for protecting system from communication error.
- ⚠ The output signal or communication lines should be separated from the power line or high tension wire. They should be installed 100mm(3.94 Inch) or more from each other.

■ Wiring Precautions Warning

- ⚠ Be sure the wiring is done correctly by checking the product's rated voltage and the terminal layout. Incorrect wiring could result in fire, damage or malfunctions.
 - ⚠ Tighten the terminal screw with the specified torque. If the screws of terminal are loose, it could result in short circuit, fire, malfunctions.
- FG Terminal must be used a dedicated ground. Not doing so could result in malfunctions.
- ⚠ a. Grounding should be the Class 3 grounding. The cable for grounding should be more than 2mm².
 - ⚠ b. grounding point be closed to the products and make short the distance to the ground cable if possible.
- Please see below.

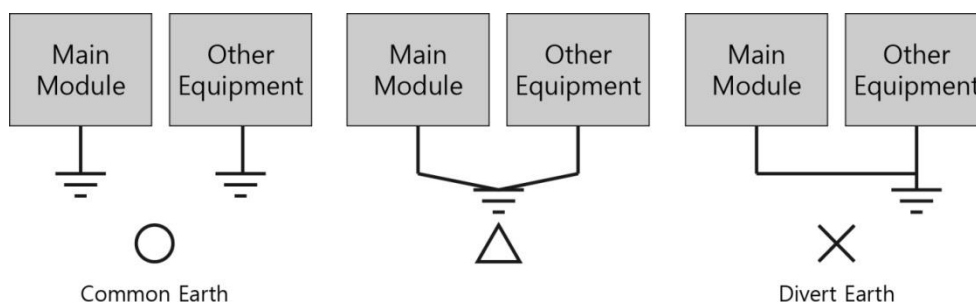



Fig. Grounding Example Diagram

■ Installation Precaution

- ⊘ Do not install the location which exceeds allowed temperature. Product can be damaged or shorten the life. Especially Install environment as below should be avoided.
- ⊘ Do not Install product to the place which the ambient temperature is out of limits, from -10 ~ 50°C or on the surface of control board which high pressure equipment is installed.

- ⊘ Do not install to the place where strong shock or vibration continuously have impacted on product.
- ⊘ For indoor use only.
- ⊘ Use the product under 2000M altitude.
- ⊘ The length of the power cable must be no more than 3m(10feet).

■ Disposal Precaution  **Caution**

When you dispose of product and battery, please treat it as industrial waste. It can create poisonous substances or explosion.

■ Battery Specification

Mounted on mainboard Model CTL920F Battery is not replaced by the user. If the battery has run out of service, please contact our Customer Support Center for replacement and inspection.

Item	Content
Battery Voltage	DC 2.3V, 7.7mAh
Battery Model	CTL920F (lithium Rechargeable / non-exchangeable)
Battery Lifetime	Permanent (In case of ambient temperature 25°C)

* The specifications are subject to change depending on the model.

■ All field-wiring connections to this unit shall be from Limited Voltage / Limited Current, below 20 ~ 28Vdc isolated secondary source with an output fuse, or Class2 secondary circuits.

Chapter 2 Overview



2.1 Introduction of Products



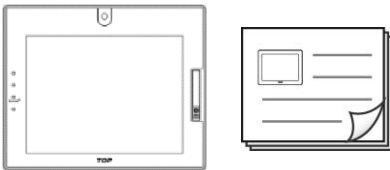

This industrial HMI touch panel is an industrial control device required in industrial field. It is a device based on RS-232C and RS-422/485, Ethernet which is used for the basic purpose of communication with another device (PLC).

2.2 Package Contents

The components of the product are as follows.

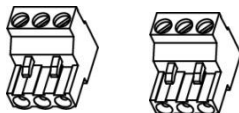
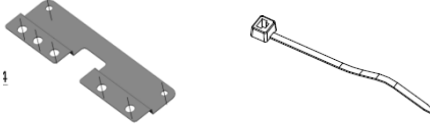
Before using the product, please check that all of the following components are included.

Item	Figure	Quantity
Product and User Manual		1
Gasket		1

Mounting Clamp		10
Power Connector and COM3 communication connector		1
USB Cable Clamp Cable Tie		1
Accessories (Sold separate)	 USB Memory  USB Cable  SD Card  Front Protect Sheet	User Option

2.3 Explanation of Model name

TOPR	T	□□	□□	□	□	-Ex	□□□
Series	Type	Screen	Option	Resolution	Power	Explosion proof	Reserve
	P: Process	08: 8.4"	10: TOPRP10D + TOPRD **10*	Q: QVGA(320*240)	D: DC	Ex:: Explosion proof or special model	Customer option: No relate to Explosion proof
	D: Display	10: 10.4"	20: TOPRP10D + TOPRD **20*	V: VGA(640*480)	A: AC	Blank: Non-explosion proof or general model	
	T: P + D	12: 12.1"	30: TOPRP10D + TOPRD **30*	S: XGA(800*600)			
		15: 15.0"	40: premium*	X: XGA(1024*768)			
				* EX model of 1210" has "S" for XGA			

** TOPRT1210SD-Ex is combined by TOPRP10D and TOPRD1220X.

2.3.1 Process Module (Main Unit)

TOPR	P	□□	□
Series	Type	Option	Power
	P: Process	10: Standard	D: DC
	T: P + D	50: Standard(10) + Performance improvement	

2.3.2 Display Module (Accessory Unit)

TOPR	D	□□	□□	□
Series	Type	Screen	Option	Resolution
	D: Display	08: 8.4"	10: Standard	Q: QVGA(320*240)
		10:10.4"	20: Premium	V: VGA(640*480)
		12: 12.1"	30: "20" Premium + Added Function/Option	S: SVGA(800*600)
		15: 15.0"		X: XGA(1024*768)

Chapter 3 General Specifications

3.1 Electrical Specifications

Input voltage	Powered by Process	DC 24V, Class 2	
Rated voltage		DC 20~28V, Class2	
Power Consumption	Process Module	TOPRP10D	6W
		TOPRP50D	9W
	Display Module	TOPRD1220X	6W
		TOPRD1230X	9W
		TOPRT1210SD-Ex (TOPRP10D + TOPRD1220X)	15W
		TOPRT1230XD-Ex (TOPRP10D + TOPRD1230X)	18W
TOPRT1240XD-Ex (TOPRP50D + TOPRD1230X)	18W		

3.2 Display Specifications

Color	16M Color
Brightness Level	10 Level(by software)
Backlight Type	LED
Backlight Life	50,000 hours
Display Font	MS Windows Vector font possible Image font
Front LED Indicate	Built in

3.3 Touch Specifications

Part	Specification	Model
Touch Type	Built-in, Analog resistive touch sensor	TOPRT ** 10 / 30 / 40

3.4 Sub Function Specifications (*Premium models only)

Part	Specification	Model
Front Camera	Built-in, Resolution: VGA(640*480)	TOPRT ** 10 / 30 / 40
Proximity Sensor	Built-in, Sensing Distance 0.7M	TOPRT ** 10 / 30 / 40
Brightness Sensor	Built-in, Brightness controls automatically as 10 level	TOPRT ** 10 / 30 / 40
IrDA	Built-in, 0.7M, Exclusive products only	TOPRT ** 30 / 40

3.5 Memory Specifications

Screen Memory	128MB
Backup Memory	512KB: System buffer(10K Word), Including Alarm/Log/Recipe
Backup Period	Permanent

Real Time Clock	Built in(by Battery)
-----------------	----------------------

3.6 Environment Specifications

Operation Temperature(°C)	-10 ~ +50
Storage Temperature(°C)	-20 ~ +60
Operation Humidity(%RH)	0 ~ 90 (No dew)
Atmosphere	No corrosive gas
Protection Classification	Front IP54

3.7 Structure Specifications

Cooling System	Natural air circulation
Case Material	AL(Aluminum)

Chapter 4 Part Names and General Specifications

4.1 TOPRT1210SD-Ex

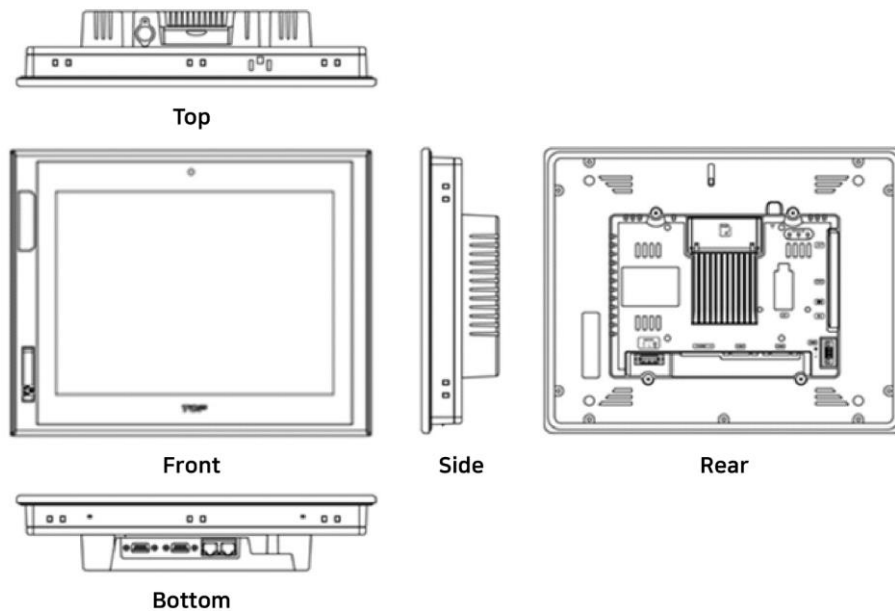

4.1.1 TOPRT1210SD-Ex External Dimension

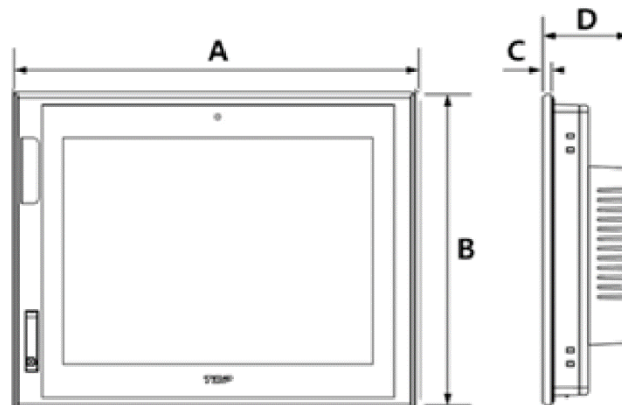

Product	A	B	C	D
TOPRT1210SD-Ex	320	261	5	66.5

4.1.2 TOPRT1210SD-Ex Front Part Names and Specifications

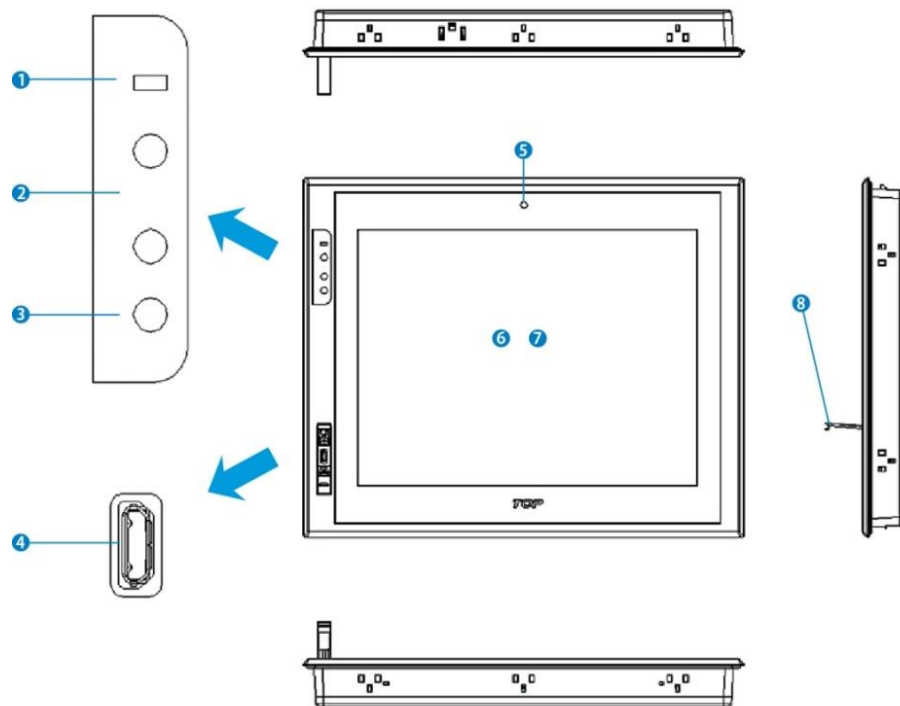

No.	Part	Description	Support Model
①	Power LED	System Power Status LED	Common
②	Proximity Sensor	Automatically backlight ON/OFF by sensing object coming	Option
③	Brightness Sensor	Automatically brightness controls by ambient brightness	Option
④	USB OTG	UP/Down load project file	Common
⑤	Camera	Resolution VGA(640*480)	Option
⑥	LCD Panel	TFT 16M Color LCD	Common
⑦	Touch Panel	Analog resistive touch sensor	Common
⑧	USB OTG Cover	Front USB OTG cover hole	Common

4.2 TOPRT1230XD-Ex / TOPRT1240XD-Ex

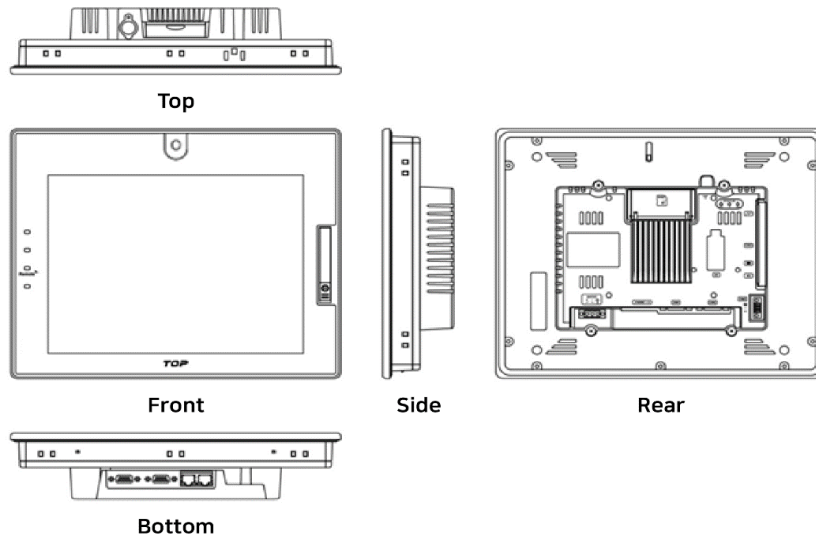

4.2.1 TOPRT1230XD-Ex / TOPRT1240XD-Ex External Dimension

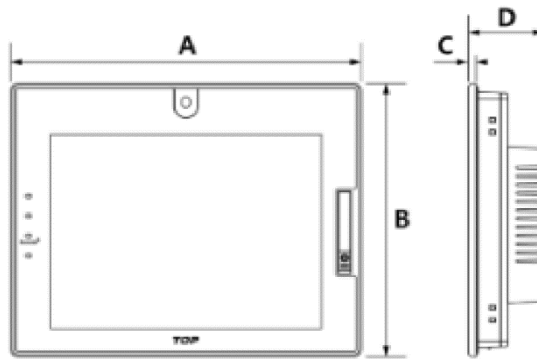

(mm)

Product	A	B	C	D
TOPRT1230XD-Ex	320	261	5	66.5
TOPRT1240XD-Ex	320	261	5	66.5

4.2.2 TOPRT1230XD-Ex / TOPRT1240XD-Ex Front Part Names and Specifications

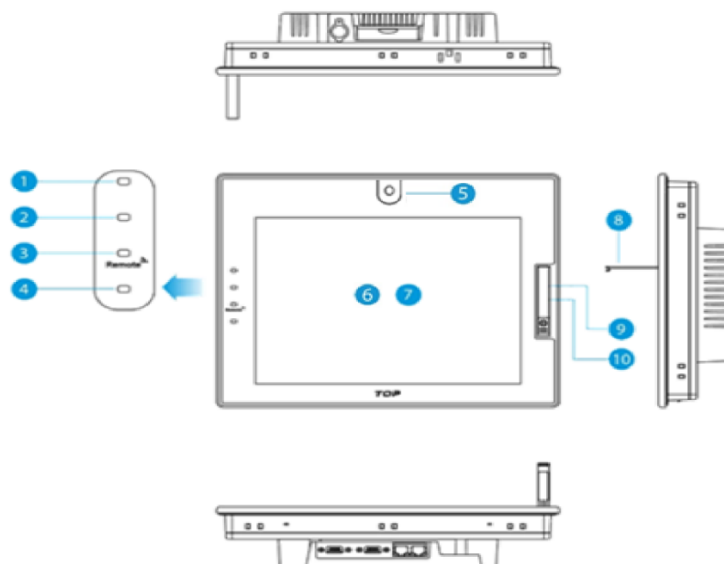

No.	Part	Description	Support Model
①	Power LED	System power status LED	Common
②	Proximity Sensor	Automatically backlight ON/OFF by sensing object coming	Common
③	IR Sensor	Device for communication with dedicated equipment	Common
④	Brightness Sensor	Automatically brightness controls by ambient brightness	Common
⑤	Camera	Resolution VGA(640*480)	Option
⑥	LCD Panel	TFT 16M Color LCD	Common
⑦	Touch Panel	Analog / Capacitive resistive touch sensor	Option
⑧	USB Cover	Front USB cover hole	Common
⑨	USB OTG	Program upload or download	Common

4.3 TOPRT12-Ex Series-Rear Part Names and Specifications

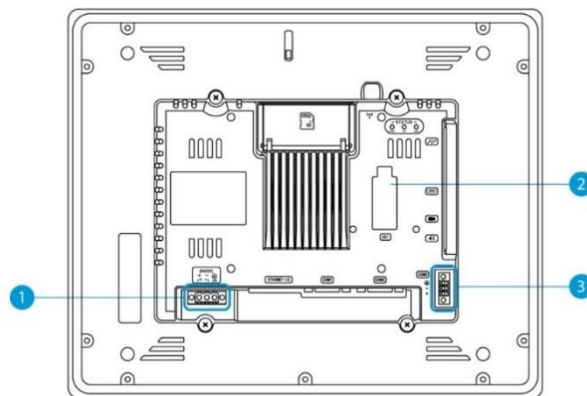

No.	Part	Form	Description
①	Power Connector	TB 5mm 3P	Power Supply for Product(DC 20~28V)
②	Extension Connector	-	Expansion module mounting cover
③	COM3 Connector	TB 3.5mm 3P	RS-485 Serial Communication Connector

4.4 TOPRT12-Ex Series- Side Part Names and Specifications



No.	Part	Form	Description	Model
①	USB HOST	A Type x 2ch.	Connector for option for USB storage. 5V/0.5A limit	TOPRT1210SD-Ex TOPRT1230XD-Ex
			Connector for option for USB storage. 5V/0.9A limit	TOPRT1240XD-Ex

4.5 TOPRT12-Ex Series- Top Part Names and Specifications

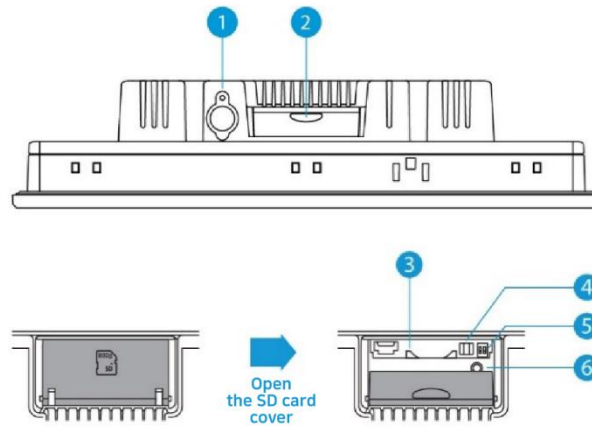

No.	Part	Form	Description	Etc.
①	External antenna connector	SMA FEMALE	External antenna connector	Option
②	SD Card Cover	Plastic Cover	SD Card, Reset Switch, Mode Switch included	
③	SD Card Socket	SD Card Socket	Data upload / download	
④	Cover Sensor	Photo coupler	Cover open / close detection	
⑤	Mode Switch	DIP Switch 2P	Set Up System Mode	
⑥	Reset Switch	Tact Switch	System reset Switch	

4.6 TOPRT12-Ex Series- Bottom Part Names and Specifications

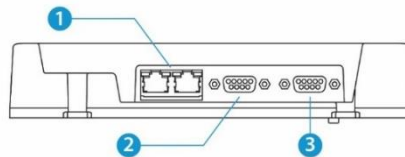

No	Part	Form	Description	Model
①	Ethernet Connector	RJ45 x 2ch	10BASE-T/100BASE-TX, Auto-MDIX	TOPRT1210SD-Ex TOPRT1230XD-Ex
			10BASE-T/100BASE-TX/1000BASE-T, Auto-MDIX	TOPRT1240XD-Ex
②	COM1	DSUB9 (female)	RS-232C/422/485 communication port (Switchable the Comm. Software select)	Common
③	COM2	DSUB9 (female)	RS-232C/422/485 communication port (Switchable the Comm. Software select)	Common

Chapter 5 External Device Interface

In order for the main unit to communicate with an external device, please check below contents.

5.1 Serial Interface

5.1.1 RS-232C

Items	Contents
Protocol	Full Duplex
Synch	Asynchronous

Communication Distance		About 15m
Type of Connection		1:1
Control Code		ASCII Code or HEXA Code
Transmission Speed		2400, 4800, 9600, 19200, 38400, 57600, 76800, 115200, 187500bps
Data Type	Data Bit	7, 8 bit
	Parity Bit	NONE, ODD, EVEN Parity
	Stop Bit	1, 2 bit
Modular Jack		DSUB 9Pin

5.1.2 RS-422/485

Items		Contents
Protocol		Full Duplex / Half Duplex
Synch		Asynchronous
Communication Distance		About 500m
Type of Connection		1:N (N≤31)
Control Code		ASCII Code or HEXA Code
Transmission Speed		2400, 4800, 9600, 19200, 38400, 57600, 76800, 115200, 187500bps
Data Type	Data Bit	7, 8 bit
	Parity Bit	NONE, ODD, EVEN Parity
	Stop Bit	1, 2 bit
Modular Jack		DSUB 9Pin

5.1.3 COM1 Connector pin number and Signal name

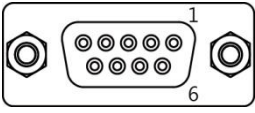
Type	Pin No.	Signal	Direction	Meaning
9Pin Female 	1	RDA(RD+)	Input	RS-422/485Data Receive(+)
	2	RD(RxD)	Input	RS-232C Data Receive
	3	SD(TxD)	Output	RS-232C Data Send
	4	RDB(RD-)	Input	RS-422/485Data Receive(-)
	5	SG	-	Signal Ground
	6	SDA(SD+)	Output	RS-422/485Data Send(+)
	7	VCC *1	-	+5V, 0.2A
	8	N.C	-	N.C
	9	SDB(SD-)	Output	RS-422/485Data Send(-)

*1) If VCC is required for an external device, connect pin 7(+ 5.0V) and pin 5. (*0.2A output)

5.1.4 COM2 Connector pin number and Signal name

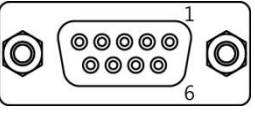
Type	Pin No.	Signal	Direction	Meaning
9Pin Female 	1	RDA(RD+)	Input	RS-422/485 Data Receive(+)
	2	RD(RxD)	Input	RS-232C Data Receive
	3	SD(TxD)	Output	RS-232C Data Send
	4	RDB(RD-)	Input	RS-422/485 Data Receive(-)
	5	SG	-	Signal Ground
	6	SDA(SD+)	Output	RS-422/485 Data Send(+)
	7	RTS	Output	RS-232C Send Request Signal
	8	CTS	Input	RS-232C Send Available Signal
	9	SDB(SD-)	Output	RS-422/485 Data Send(-)

5.1.5 COM3 Connector pin number and Signal name

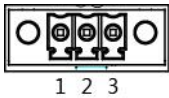
Type	Pin No.	Signal	Direction	Description
	1	D+	I/O	RS-485 Data (+)
	2	D-	I/O	RS-485 Data (-)
	3	SG	-	Signal Ground

*Be sure to connect the RD and SD to the RS-232C communication line by crossing each other with a Twisted Pair Cable. Please connect SG directly.

*RS-422/485 communication line must use RDA and RDB as Twisted Pair Cable, SDA and SDB as Twisted Pair Cable.

5.2 Ethernet Communication Specifications

5.2.1 Ethernet

Item		Description
Ethernet Method	TOPRT1210SD-Ex	IEEE802.3i/IEEE802.3u, 10BaseT / 100BaseT
	TOPRT1230XD-Ex, TOPRT1240XD-Ex	IEEE802.3i/IEEE802.3u/IEEE802.3ab, 10BASE-T/100BASE-TX/1000BASE-T
Speed	TOPRT1210SD-Ex	10M / 100Mbps
	TOPRT1230XD-Ex, TOPRT1240XD-Ex	10M / 100Mbps / 1Gbps
Communication Method		Base Band
Switching Method		AUTO MDIX
Maximum Segment Length		100M (Hub between product)
Communication Cable		UTP (Unshielded Twisted Pair)
Modular Jack		RJ45 x 2ch

5.2.2 RJ-45 Pin Layout

Type	Pin No.	Color	10M/100MHz	1GHz	Model
	1	Orange/White	TD+	BI_DA+	Common
	2	Orange	TD-	BI_DA-	Common
	3	Green/White	RD+	BI_DB+	Common
	4	Blue	Unused	BI_DC+	TOPRT1240XD-Ex
	5	Blue/White	Unused	BI_DC-	TOPRT1240XD-Ex
	6	Green	RD-	BI_DB-	Common
	7	Brown/White	Unused	BI_DD+	TOPRT1240XD-Ex
	8	Brown	Unused	BI_DD-	TOPRT1240XD-Ex

*When HUB is used, Straight cable should be used.

Ex) Straight Cable Wiring: Connect 1:1 according to the wiring diagram above.

*In case of connected directly without HUB, Cross Cable should be used.

Ex) Cross Cable Wiring: In the above wiring diagram, TD+ and RD+ are changed, and TD- and RD- are exchanged.

5.3 USB Interface

5.3.1 USB Host

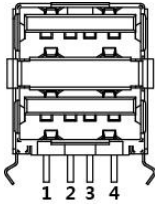
Type	Items		Specifications
	USB Interface	TOPRT1210SD-Ex	EHCI/OHCI Specification Version 1.0, USB2.0/1.1 Compatible
		TOPRT1230XD-Ex TOPRT1240XD-Ex	EHCI/OHCI Specification Version 1.0, USB3.0/2.0/1.1 Compatible
	Communication Method		Control/Bulk
	Transfer Speed	TOPRT1210SD-Ex	Max. 480Mb/s
		TOPRT1230XD-Ex TOPRT1240XD-Ex	Max. 5Gb/s
	Support Device		USB Storage (FAT16/FAT32 Format Available)
	Connector Type		Type A(2ch)

5.3.2 USB Device

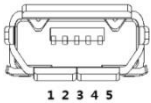
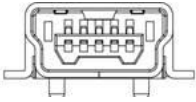
Type	Items	Specifications
 	USB Interface	USB 2.0
	Communication Method	Interrupt/Bulk/Isynchronous
	Transfer Speed	480Mb/s
	Supported OS	Windows 98SE/2000/XP/VISTA/7/10(32/64bit)
	Cable Length	M2I manufacturer's cable is recommended(3M), and 1.5M or less when purchased separately.
	Connector Type	Micro USB AB, Female
	Connection Method	Through USB Connector on Front Side of Display Module

Chapter 6 Installation Warning

6.1 Installation Requirement

- (1) It should be installed within $-10 \sim 50^{\circ}\text{C}$ and 10~80% relative-humidity, otherwise the screen may be changed or cause malfunction and damage.
- (2) The degrees of protection should be made sure IP54 of Front.
- (3) Be sure that heat from surrounding equipment does not cause product to exceed its standard operating temperature.

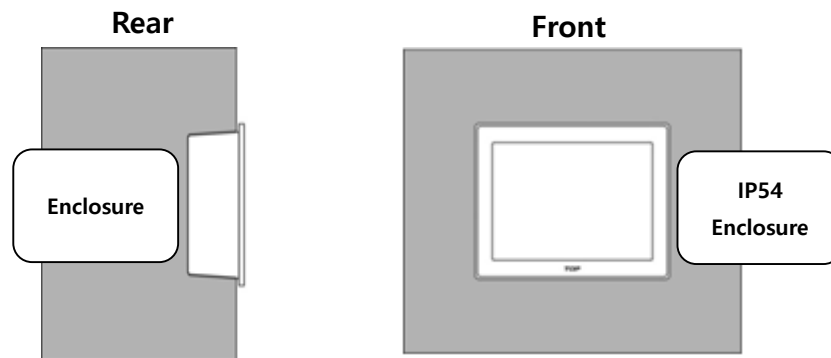

- (4) In order to minimize external mechanical hazards for maintaining Explosion proof performance, please control the mechanical hazards of the surrounding environment.

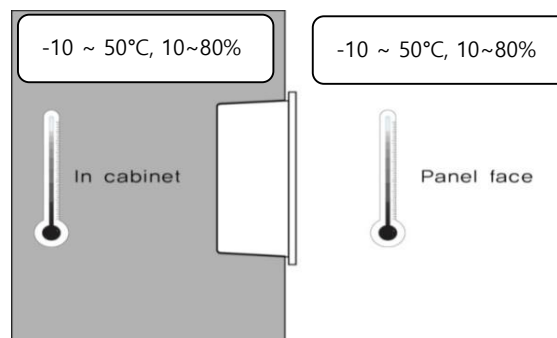

6.2 TOPRP Assemble

Insert Process Module to Guide of Rear of Display Module and Mount with Bolts included in Package.
(Bolt Size: M4x8L, 0.2N.m)

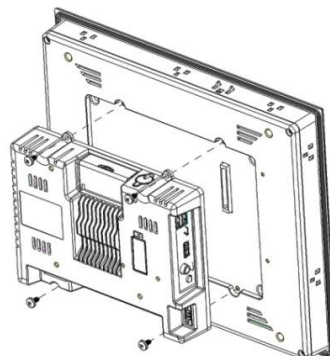

6.3 Installation Procedure Warning

Please follow to below instructions to install the product.

6.3.1 Direction

It is recommended that the power connector at the rear is located at the top for vertical installation.

(1) TOPRT1210SD-Ex

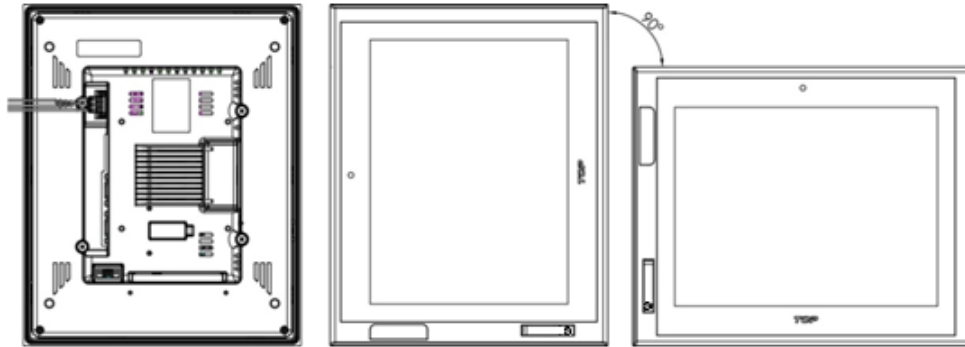

(2) TOPRT1230XD-Ex / TOPRT1240XD-Ex

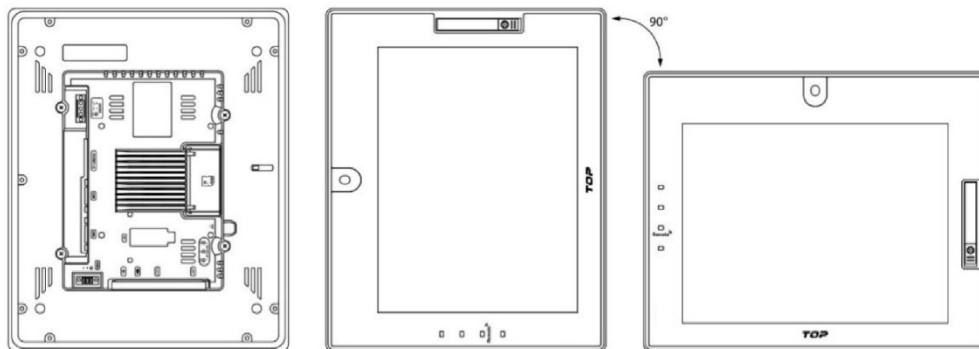

6.3.2 Panel Cut-out

Make a panel cut which product is mounted and insert the TOPR to the panel form the front side.

(1) The Size of Panel Cut (Mounting Place)

Making the Panel Cut (Mounting Size) per each model as below Table, Before Installation.

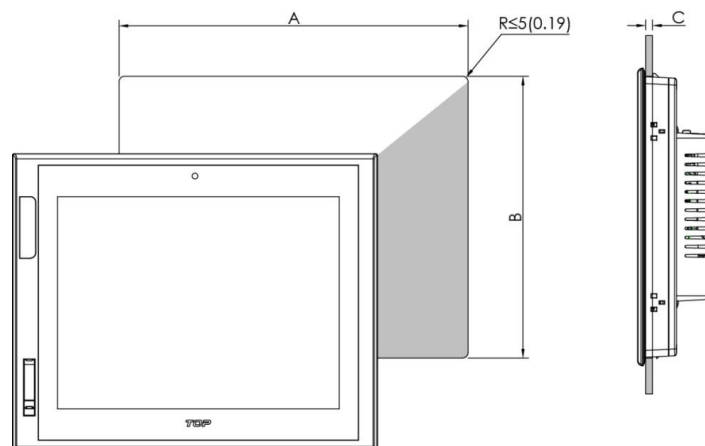

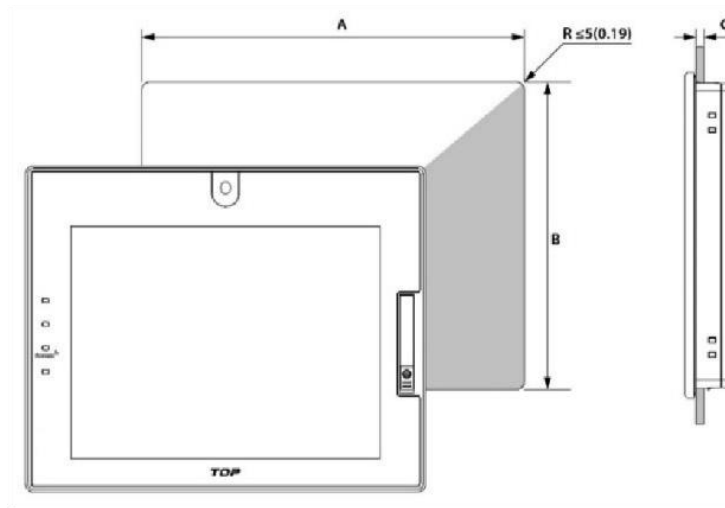

(mm)

Model	A	B	C
TOPRT12 Series	306(+1.0/0)	247(+1.0/0)	1.6~5.0(+1.0)

6.3.3 Fixation  **Warning**

Installation methods should be following by using the supplied installation clamps for IP performance.

(1) Insert the clamp into the slot of the product.

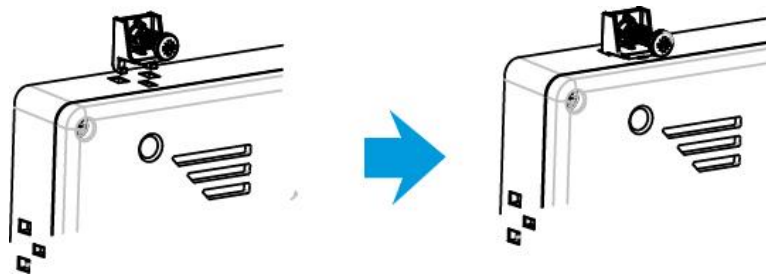

(2) Screw the unit into the panel cut with a screwdriver.

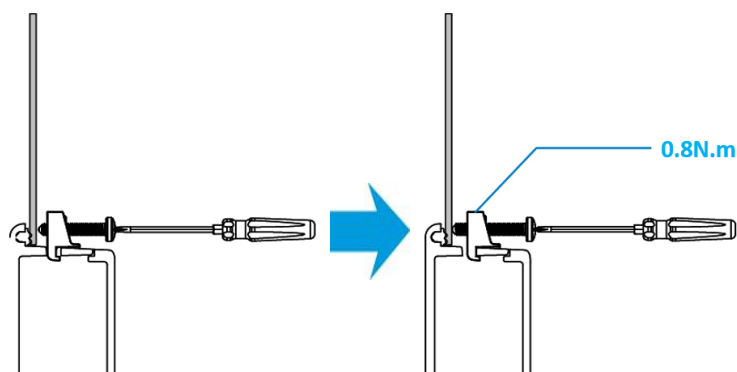

Note: If the clamping screw below is over-tightened, the touch sensor may stop working or malfunction. Tighten to 0.8N.m screwdriver torque.

Caution: IP performance cannot be secured if the clamp is not tightened with a tightening force of 0.8N.m.

6.4 Front USB

6.4.1 Front USB Cover Open/Close

- (1) TOPRT1210SD-Ex: Turn left or right the locking screw on the USB cover.
- (2) TOPRT1230XD-Ex / TOPRT1240XD-Ex: Place the locking screw or horizontally(Open) or vertically(Close).

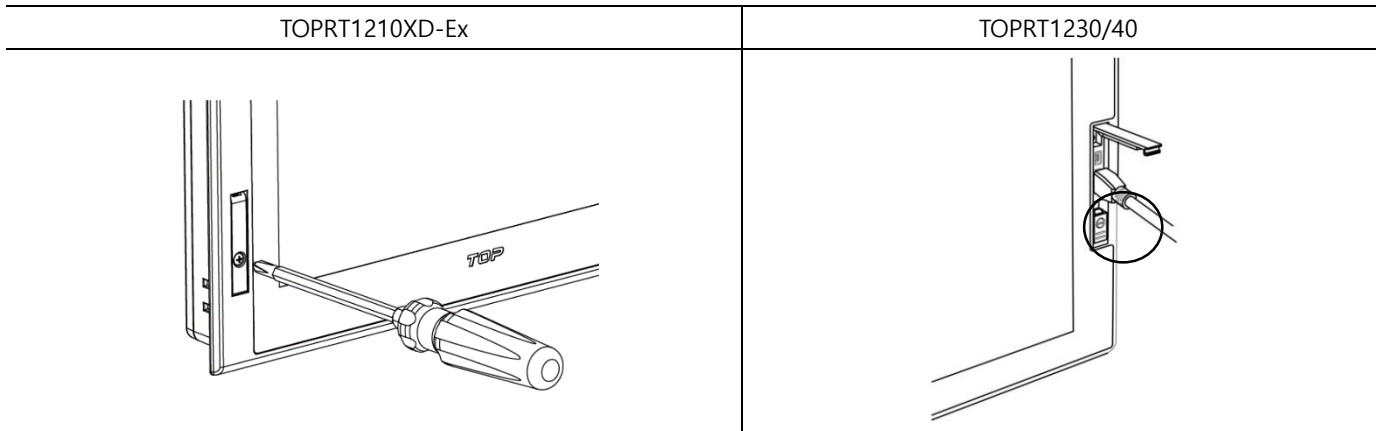

6.4.2 Data Upload and Download

You can download or Upload Project file data by connecting USB cable.

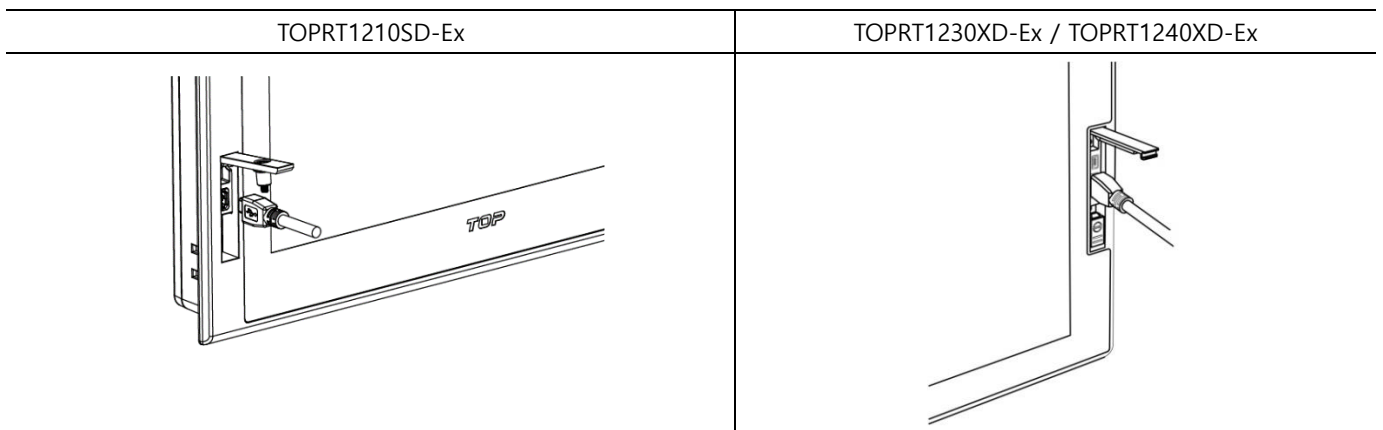

※ Do not use USB in explosive circumstances. There can be an explosion during operation.

Chapter 7 Wiring Warning

7.1 Power wiring Warning

(1) The Power cable should have the following specification.

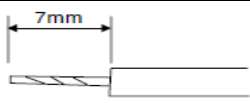
Power Cable Specification	0.75~2.5mm ² (18~12AWG)
F.G Cable Specification	2mm ² (14AWG)
Conductor type	Simple or Stranded wire
Bolt torque	≥ 0.6N.m
Conductor length	
Temperature rating of the field installed conductors	65°C or under

(2) The Power terminal has following specifications. **⚠ Caution**

Caution: The use of the Pin Terminal(ferrule) when installing the power supply and ground terminal is important for maintaining the performance of the device. Failure to install power and ground using the same Pin Terminal(ferrule) as below may cause explosion due to spark due to abnormal cable loss. Therefore, please be sure to familiarize yourself with how to use Pin Terminal(ferrule) below.

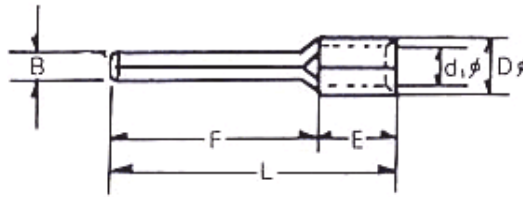

(mm)

B	L	F	E	D	d
1.8~2.0	22~18	12~14	5	3.3~3.8	2~2.5

(3) Wiring of power is as follows. **⚠ Warning**

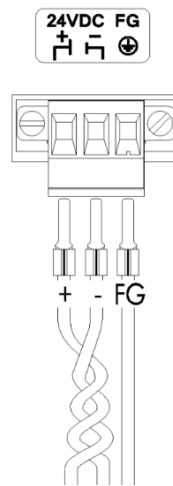

7.2 Ground wiring **⚠ Warning**

(1) The product has enough anti-noise measure, so except that there are many noises. Especially, the ground is not needed. When doing ground, please refer to the followings.

(2) The ground should be the exclusive ground. The ground should be type class 3 ground (ground resistor is less than 100Ω)

(3) When not doing the exclusive ground, do common ground like figure B.

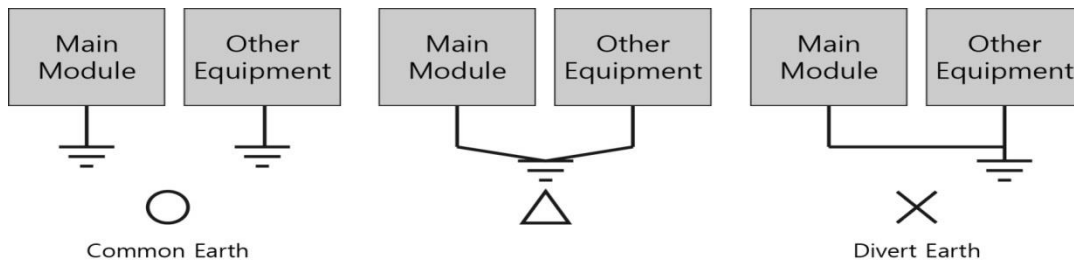

Fig. Grounding Example Diagram

(4) Use the cable width more than 2mm². Put the point of the ground near product and shorten Ground line.

7.3 Cable Clamp Installation Caution

CAUTION: If you use an extension cable on the USB terminal block, install the cable clamp to prevent the USB connection from being disconnected or sparking because the cable is disconnected.

(1) Place cable clamp at the screw hole on Rear of the product and turn the screw to fix it.

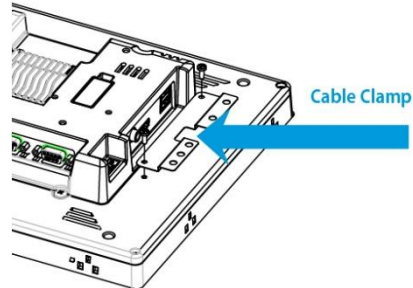

(2) Insert USB connector to USB port of the product and pass the cable tie through hole of cable clamp.

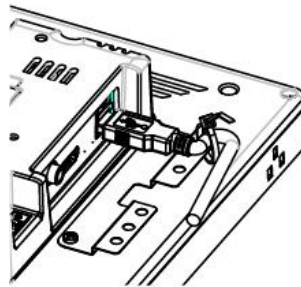

(3) Tighten cable clamp and USB cable with the cable tie sufficiently and check that the USB connector is not pulled out by external force.

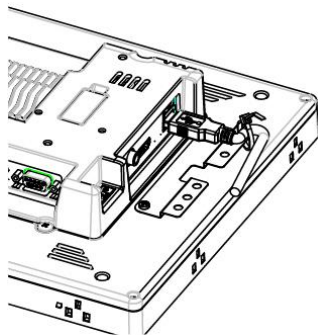

Chapter 8 Maintenance Warning

8.1 Cleaning the Display

When the surface or frame of the display become dirty, spray the cleaning solution onto a soft cloth and wipe the device. Do not spray the cleaning solution directly onto the device.

8.2 Periodic Check Points

Check the followings periodically for best condition of the device.

(1) Environment

- Is the operating temperature within the allowable range(-10~50°C)?
- Is the operating humidity within the allowable range(10~80%RH)?
- Is the Surrounding pollution no corrosive gas?

(2) Power

- Is the input voltage within the change range ($\pm 15\%$)?

(3) Related Items

- Check the battery when is exchanged and voltage drop is indicated.
- Check the guarantee duration of LCD Backlight by eye.
- Check the touch pad there is no damage, scratch or pollution by eye.

8.3 Problems with the Device Warning

- If there is a problem during operation, stop using it and contact the A/S department of M2I, which is indicated on the product label.
- Only the authorized worker from M2I can check and repair problems related to malfunction of the machine.
- If the problem cannot be solved at the installation site, the equipment can be collected and moved to M2I.
- The manufacturer, M2I, is not responsible for damage or malfunction of the equipment caused by the use conditions of the user beyond the installation and use standards described in the manual.

8.4 Setting System Recovery Mode



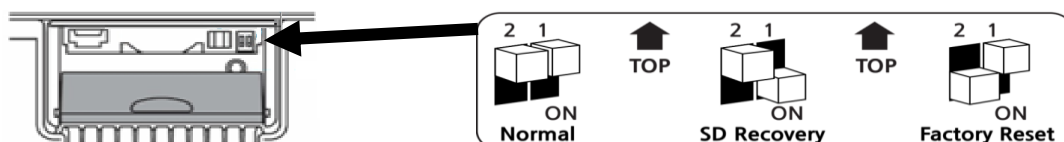



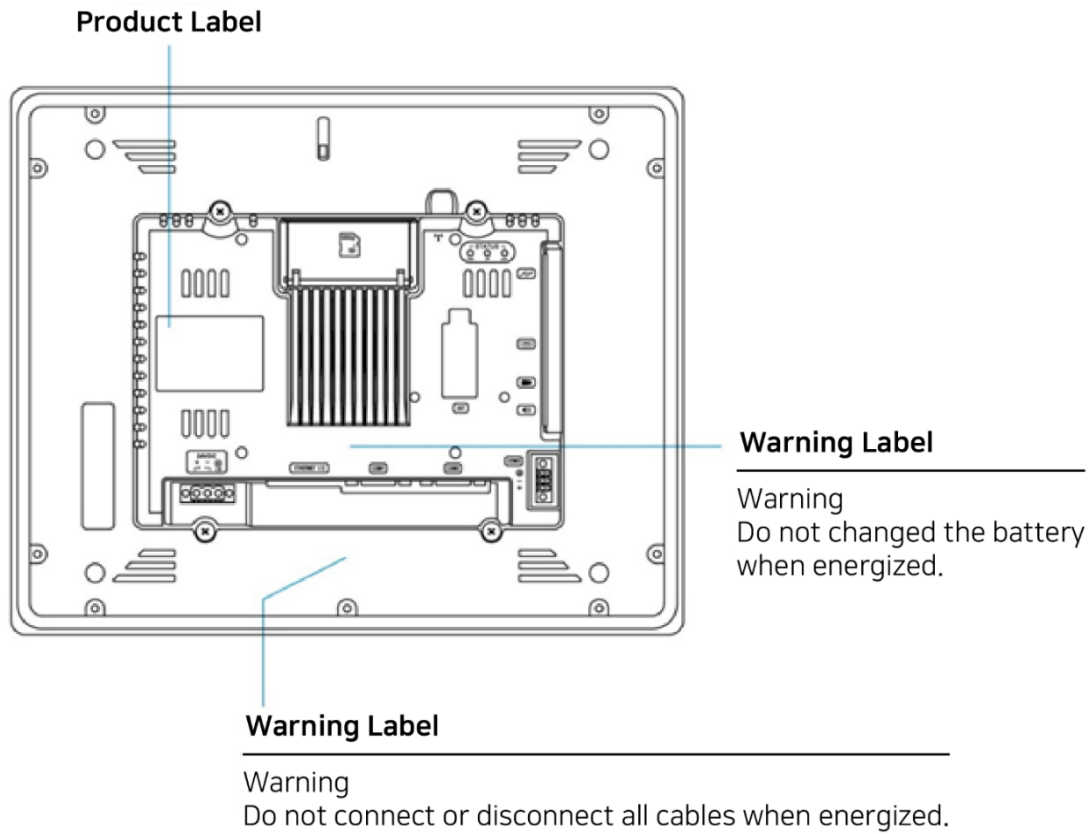

- If the system fails to boot normally due to a problem during operation, the built-in recovery function can be used to maintain the factory default state. Please note that the built-in project will be deleted when using the recovery mode.
- After opening the rear cover, you can adjust the setting switch. Keep the "Normal" state when booting normally. If the system is recovering, turn off the power and set it to "Factory Reset".
- When the recovery is completed, the buzzer sounds, then turn off the power and reset to "Normal" state.



Chapter 9 Product and Warning Label



Chapter 10 Product Label

Manufacturer	→	M2I Corporation 工业操作终端	Service & Support www.m2i.co.kr
*Model	→	TOPRT12□□□□-Ex	M2I Bldg, Simin-daero 327, Anyang-si, 14055
**Power	→	IN(输入): 20~28V  class 2, □□W	Made In Korea
Battery	→	Inside Cell(内部电池): CTL920F	韩国制造
Operation Temp.	→	S / N (产品系列号): 00000 Tamb (使用温度): -10°C ≤ Ta ≤ +50°C	0.0.0 
Cautions	→	Ingress Protection(入口保护): IP54(Front/正面), 2X(Rear/背部) WARNING - POTENTIAL ELECTROSTATIC CHARGING HAZARD ⚠ See Instruction Manual. ⚠ If you need change the inside battery please contact the A/S center. ⚠ For use on a flat surface of a Type 1 Enclosure	
***Certificates / Protections	→	 ExXXXXX PROG. CNTLR. Class I Division 2 Group A,B,C,D T6 Haz.Loc  Ex nA IIC T6 XXXXXXXXXXXXXXXX  IIBG Ex ic ec IIC T6 Gc IECEx XXXXXXXXX  Ex ec IIC T6 Gc	
		 R-R-M2I-TOPRT12□□□□-Ex  	

- | | |
|-------------------|----------|
| * Model Name: | **Power: |
| - TOPRT1210SD-Ex: | 15W |
| - TOPRT1230XD-Ex: | 18W |
| - TOPRT1240XD-Ex: | 18W |

*** These can be different depends on each model. Before model selection, make sure the details to M2I.

Copyright: M2I corporation 2025.03

www.m2i.co.kr

Document No: TOPRT-D0008 Rev.0

- When using M2I equipment, thoroughly read this datasheet and associated manuals introduced in this datasheet, also pay careful attention to safety and handle the module properly.
- Store this datasheet in a safe place so that you can take it out read it whenever necessary.