



M2I Corporation

Industrial HMI Touch Panel

TOPRC Series

User Manual

Thank you for purchasing the industrial HMI touch panel series of M2I corporation.

Please read this manual carefully to know installing, wiring, operating this equipment for safe use of this product.





Index

Index	2
Chapter 1 Safety Precautions.....	3
Chapter 2 Overview	5
2.1 Introduction of Products.....	5
2.2 Package Contents.....	5
2.3 Explanation of Model name	5
Chapter 3 General Specifications	6
3.1 Power Specifications	6
3.2 Memory Specifications.....	6
3.3 Display Specifications	6
3.4 Touch Specifications	6
3.5 Wireless Communication Specifications	6
3.6 Antenna Information.....	7
3.7 Environment Specifications.....	7
3.8 Structure Specifications	7
Chapter 4 Parts Identification and Functions.....	7
4.1 TOPRC Series	7
Chapter 5 Interface	10
5.1 Serial Interface	10
5.2 Ethernet Interface.....	11
5.3 USB Interface	12
Chapter 6 Installation	12
6.1 Installation Requirements	12
6.2 Install Procedure	13
6.3 Front USB	14
Chapter 7 Wiring	15
7.1 Power Cable Wiring.....	15
7.2 Ground wiring	16
Chapter 8 Maintenance	16
8.1 Cleaning the Display	16
8.2 Periodic Check Points.....	17
8.3 Problems with the Device.....	17
8.4 Setting System Recovery Mode.....	17
Chapter 9 Products and Warning Label Location	18

Chapter 1 Safety Precautions







■ Before using the product

To use the product safely and effectively, please read the contents of this manual thoroughly before use. Please keep to the safety precaution, for it is to prevent accidents and potential danger from occurring. Safety precaution is classified into 'Warning' and 'Caution' and their meanings are as follows. Also, the indicated illustrations on the product and in the manual have the following meanings.

 Warning	Violating the instruction may result in serious personal injury or death
 Caution	Violating the instruction may result in slight personal injury or product damage
	Be cautious, for danger may be present
	Be cautious, for there is a possibility of an electric shock



■ General Precautions Caution

Do not install the location which exceeds allowed temperature. Product can be damaged or shorten the life. Especially Install environment as below should be avoided.

-  Do not press the screen with a hard or sharp object (awl, screwdriver, pen) with too strong a force. It may cause malfunction of touch due to damage of the front sheet.
-  Do not use or store in an environment with high vibration.
-  Do not allow foreign objects such as water, liquids, or metal powders to enter the product. This may cause breakage or electric shock.
-  Use the radio or mobile phone at least 30cm away from the main unit.
-  Two or fewer bright spots may appear on the LCD screen, and certain areas may appear brighter, but this is not a defect in LCD characteristics.
-  Do not store or operate in direct sunlight. Direct sunlight can change the properties of the LCD.

■ Design Precautions Warning

Install protection circuit on the outside of Products to protect the entire control system when external power supply or Products have problems.

-  As the malfunction & incorrect result of Products could damage the stability of the entire systems and human body, you must install damage preventing interlock circuit such as emergency stop, Protective circuits, positioning upper and lower limit switch and interlock for forward/reverse operation.
-  When computer or other controllers communicate and exchange data with products or change operation mode of products, set up protective sequence program in PC or Controller for protecting system from communication error.
-  The in/output signal or communication lines should be separated from the power line or high-tension wire. They should be installed 100mm (3.94 Inch) or more from each other.

■ Wiring Precautions **⚠ Warning**

- ❗ Be sure the wiring is done correctly by checking the product’s rated voltage and the terminal layout. Incorrect wiring could result in fire, damage or malfunctions.
- ❗ Tighten the terminal screw with the specified torque. If the screws of terminal are loose, it could result in short circuit, fire, malfunctions.
FG Terminal must be used a dedicated ground. Not doing so could result in malfunctions.
- ❗ a. Grounding should be the Class 3 grounding. The cable for grounding should be more than 2mm².
- ❗ b. grounding point be closed to the products and make short the distance to the ground cable if possible.

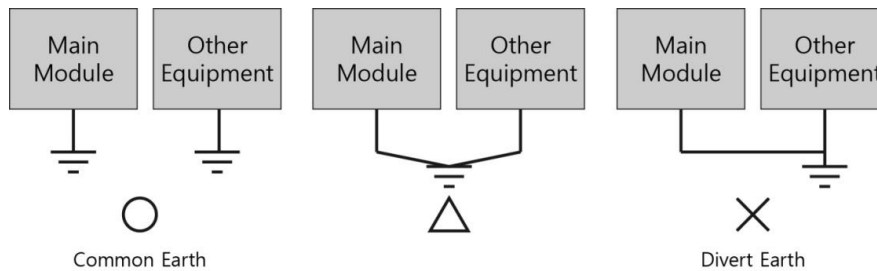

Fig. Grounding Example Diagram

■ Installation Precautions

Do not install the location which exceeds allowed temperature. Product can be damaged or shorten the life. Especially Install environment as below should be avoided.

- ⊘ Do not Install product to the place which the ambient temperature is out of limits, from -10°C to 50°C or on the surface of control board which high pressure equipment is installed.
- ⊘ Do not install to the place where strong shock or vibration continuously have impacted on product.
- ⊘ Do not store or operate in direct sunlight. Direct sunlight can change the properties of the LCD.
- ⊘ For indoor use only.
- ⊘ Use the product under 2000M altitude.

■ Disposal Precaution

When you dispose of product and battery, please treat it as industrial waste. It can create poisonous substances or explosion.

■ Internal Battery Specifications and Replacement **⚠ Caution**

- ⊘ A CR2032 internal battery on Mainboard can be replaced in non-explosive location only. Please check below information to correct replacement.

Item	Information
Voltage and capacity	DC 3.0V, 225mAh
Model name and manufacturer	CR2032(Lithium Battery), Panasonic
Lifetime	More than 2 years (In case of ambient temperature 25°C)

* The specifications are subject to change depending on the model.

- All field-wiring connections to this unit shall be from Limited Voltage / Limited Current, below 20~28 Vdc isolated secondary source with an output fuse, or Class 2 secondary circuits.

Chapter 2 Overview





2.1 Introduction of Products

This industrial HMI touch panel is an industrial control device required in industrial field. It is a device based on RS-232C and RS-422/485, Ethernet which is used for the basic purpose of communication with another device(PLC).

2.2 Package Contents

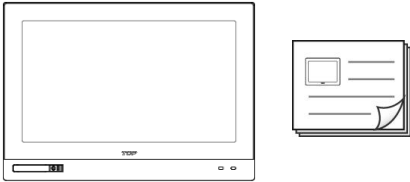
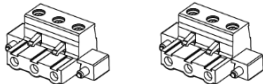
The components of the product are as follows.

Before using the product, please check that all of the following components are included.

Item	Figure	Quantity
Product and User Manual		1 each
Power Connector and COM3 communication connector		1 each
Mounting Clamp		12
Accessories (Sold separate)	 USB Memory  USB Extension Cable  SD Card	User Options

2.3 Explanation of Model name

TOPRC	□□	□□	□	□	-	Ex		□□
Series	Screen Size	Option	Resolution	Power		Anti-Explosion	Blank	Etc
	12: 12.1" 15: 15.6" 19: 18.5"	00: Standard	W: WXGA (1366x768)	D: DC		Ex: Explosion proof or special model Blank: Non-explosion proof or general model		□□: not related to anti-explosion, show as blank, digits, or letters

Chapter 3 General Specifications

3.1 Power Specifications

Rated voltage	DC 24V, Class2	
Input Voltage Range	DC 20~28V	
Power Consumption	TOPRC1200WD	40W or less
	TOPRC1500WD	
	TOPRC1900WD	
Voltage endurance	DC 24V, within 10ms	
Insulation Resistance	500V DC, 10MΩ	

3.2 Memory Specifications

Screen Memory	128MB
Backup Memory	512KB: System buffer(10K Word),Including Alarm/Log/Recipe
Backup Period	Permanent
Real Time Clock	Built in(by Battery)

3.3 Display Specifications

Color	16M Colors
Brightness Level	10 Level(by software)
Backlight Type	LED
Backlight Life	50,000 hours
Display Font	MS Windows Vector font possible Image font
Front LED Indicate	Built in

3.4 Touch Specifications

Touch Type	Capacitive Touch Sensor
------------	-------------------------

3.5 Wireless Communication Specifications

IrDA	Compliant to IrDA physical layer standard up to 115.2 kbit /s(SIR), 0.7M@ Open space communication, M2I HMI dedicated communication		
Bluetooth	Spectrum Band	2402Mhz ~ 2480Mhz	
	Standard	Bluetooth® 5.0 Low Energy (BLE)	
	Transmit Speed	1Mbps@Typ	
	Maximum Power	+0.55dBm (Including Antenna gain)	
	Operation Area	5M or more (*flat-ground communication)	
	Security (*AP Setting)	WEP(64/128), WPA-PSK+(TKIP, AES), WPA2-PSK+(TKIP, AES) *AES Recommend	
Wi-Fi	2.4 GHz	Freq. Range	2400Mhz ~ 2483.5Mhz
		Standard	IEEE 802.11b/g/n Wi-Fi compliant
		Spectrum Band	20/40 MHz
	5 GHz	Transmit Speed	300Mbps@Max
		Freq. Range	5150Mhz ~ 5725Mhz
		Standard	IEEE 802.11a/n Wi-Fi compliant

	Spectrum Band	20/40 MHz
	Transmit Speed	300Mbps@Max
	Maximum Power	2.4G: +6.38dBm (Including Antenna gain), 5G: +15.02dBm (Including Antenna gain)
	Operation Area	20M or more (*flat-ground communication)
	Security (*AP Setting)	WEP(64/128), WPA-PSK+(TKIP, AES), WPA2-PSK+(TKIP, AES) *AES Recommend

3.6 Antenna Information

Gain	2.4 GHz: Peak gain -6.02dBi, 5 GHz: Peak gain +2.98dBi
Antenna Type	Internal Antenna

3.7 Environment Specifications

Operation Temperature(°C)	-10 ~ +50
Storage Temperature(°C)	-20 ~ +60
Operation Humidity(%RH)	0 ~ 90(No dew)
Atmosphere	No corrosive gas
Vibration Endurance	Amplitude: 10≤F < 25Hz(2G) X,Y,Z each direction(for 30 minutes)
Noise Immunity	1000Vp-p(Pulse width 1μs)
Static Electricity Discharge	Connective discharge from EN61000-4-2: ±4kV
Shock Endurance	10G X,Y,Z each direction(for 3 times)
Withstand Voltage	500V(Line-Line)
Ground Connection	Class 3(100Ω 이하)
Protection Classification	Front IP65, Rear IP2X

3.8 Structure Specifications

	TOPRC1200WD	TOPRC1500WD	TOPRC1900WD
Weight (Kg)	-	3.12	-
Cooling System	Natural air circulation		
Case Material	Plastic (FRONT) + Aluminium		

Chapter 4 Parts Identification and Functions

4.1 TOPRC Series

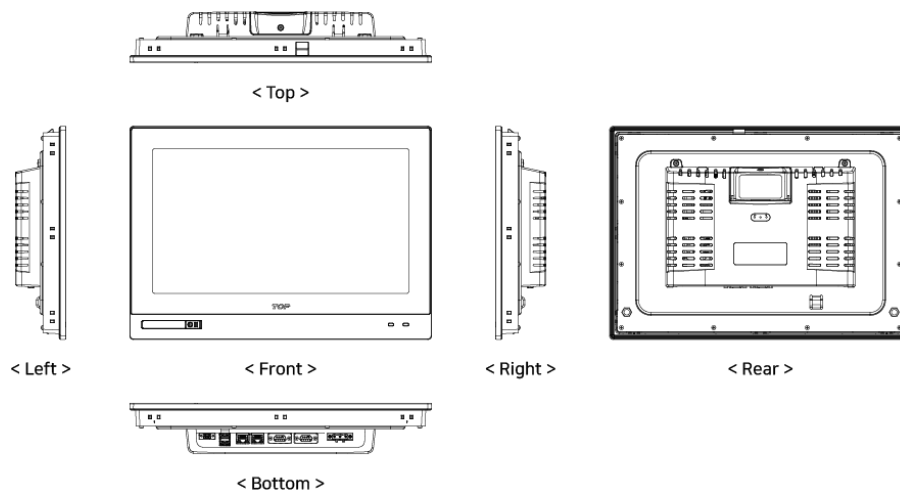

4.1.1 External Dimension

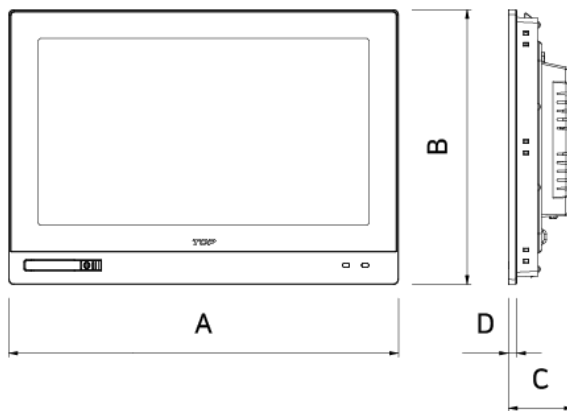

Model	A(mm)	B(mm)	C(mm)	D(mm)
TOPRC1200WD	321.4	252.4	67.5	7
TOPRC1500WD	406.4	286.4	67.5	
TOPRC1900WD	477.4	328.4	67.5	

4.1.2 Front Part Names and Specifications

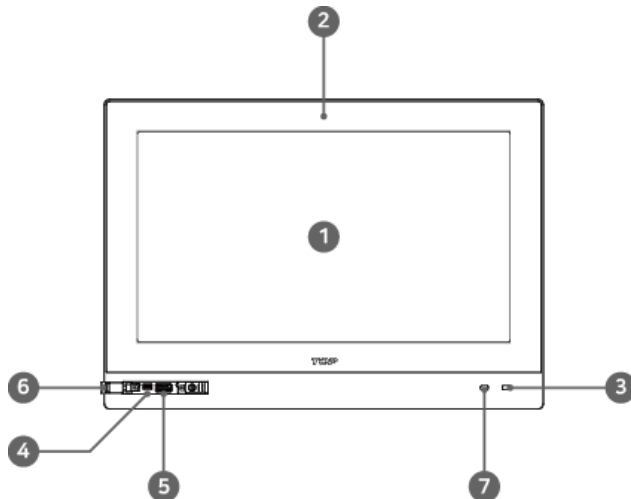

No.	Title	Description
①	LCD	TFT 16M Color LCD
②	Touch Panel	Capacitive Touch
③	Power LED	System power status LED
④	USB OTG	Project file upload/download (*Internal program managing purpose)
⑤	USB HOST	USB Connector, 5V/0.5A output
⑥	Front USB Cover	Front USB Cover
⑦	IrDA Sensor	Communication device for dedicated product

4.1.3 Rear Part Names and Specifications

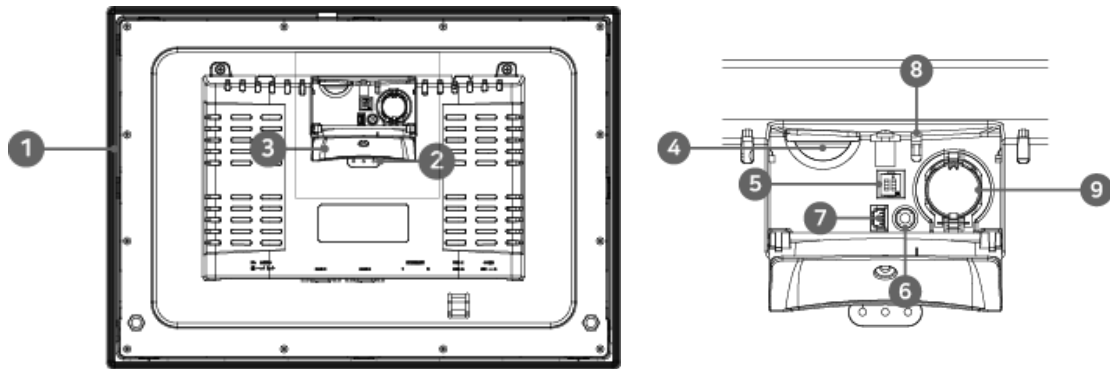

No.	Title	Form	Description
①	Rubber Gasket	-	Shock absorbing and IP specifying silicon gasket
②	LED Indicator	3개	Power, Operation, Communication status display
③	SD Card Cover	Plastic Cover	SD Card, Reset switch, Mode switch, CR2032 battery
④	SD Card Socket	SD Socket	Project or Log data file upload/download
⑤	Mode Switch	DIP Switch 2p	System mode setting switch
⑥	Reset Switch	Tact Switch	System reset switch
⑦	Diagnosis Connect	2mm 4P	System diagnosis (Manufacturer use only)
⑧	Cover Sensor	Photo coupler	Cover open/close sensing
⑨	RTC Battery	CR2032	RTC battery

4.1.4 Bottom Part Names and Specifications

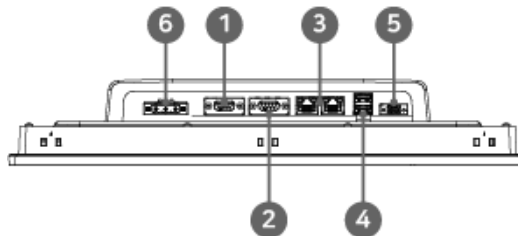

No.	Title	Form	Description
①	Serial COM1	DSUB9	RS-232C/422/485 serial comm. (select by software)
②	Serial COM2	DSUB9	RS-232C/422/485 serial comm. (select by software)
③	ETHERNET Connector	RJ45 x 2ch	10BASE-T/100BASE-TX/1000BASE-T, Auto-MDIX
④	USB Connector	Type A 2ch	Connector for USB data save option
⑤	Serial COM3	TB 3.5mm 3P	RS-485 serial communication connector
⑥	Power Terminal	TB 7.6mm 3P	Power supply for product

Chapter 5 Interface

In order to communicate with an external device, it is necessary to connect the two devices by referring to the following

5.1 Serial Interface

5.1.1 RS-232C

Item	Description	
Protocol	Full Duplex	
Synch.	Asynchronous	
Communication Distance	about 15m	
Type of connection	1:1	
Control Code	ASCII Code or HEXA Code	
Baud Rate	2400, 4800, 9600, 19200, 38400, 57600, 76800, 115200bps	
Data Type	Data Bit	7, 8bit
	Parity Bit	NONE, ODD, EVEN Parity
	Stop Bit	1, 2bit
Connector	DSUB 9pin	

5.1.2 RS-422/485

Item	Description	
Protocol	Full Duplex / Half Duplex	
Synch.	Asynchronous	
Communication Distance	about 500m	
Type of connection	1:N(N ≤ 31)	
Control Code	ASCII Code or HEXA Code	
Baud Rate	2400, 4800, 9600, 19200, 38400, 57600, 76800, 115200bps	
Data Type	Data Bit	7, 8bit
	Parity Bit	NONE, ODD, EVEN Parity
	Stop Bit	1, 2bit
Terminating Resistors	100/120Ohm (select by software)	
Connector	DSUB 9pin	

5.1.3 COM1 Connector pin number and Signal name

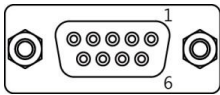
Type	Pin No.	Signal	Direction	Description
9Pin Female 	1	RDA(RD+)	Input	RS-422/485 Receive Data(+)
	2	RD(RxD)	Input	RS-232C Receive Data
	3	SD(TxD)	Output	RS-232C Send Data
	4	RDB(RD-)	Input	RS-422/485 Receive Data(-)
	5	SG	-	Signal Ground
	6	SDA(SD+)	Output	RS-422/485 Send Data(+)
	7	¹⁾ Power	-	+5V, 0.2A
	8	²⁾ SG	-	Signal Ground
	9	SDB(SD-)	Output	RS-422/485 Send Data(-)

1) ²⁾ If VCC is required for an external device, connect pin 7(+ 5.0V) and pin 8(0.2A output)

5.1.4 COM2 Connector pin number and Signal name

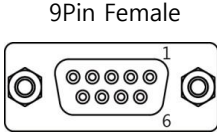
Type	Pin No.	Signal	Direction	Description
 <p>9Pin Female</p>	1	RDA(RD+)	Input	RS-422/485 Receive Data(+)
	2	RD(RxD)	Input	RS-232C Receive Data
	3	SD(TxD)	Output	RS-232C Send Data
	4	RDB(RD-)	Input	RS-422/485 Receive Data(-)
	5	SG	-	Signal Ground
	6	SDA(SD+)	Output	RS-422/485 Send Data(+)
	7	RTS	Output	RS-232C Request to Send
	8	CTS	Input	RS-232C Clear To Send
	9	SDB(SD-)	Output	RS-422/485 Send Data(-)

5.1.5 COM3 Connector pin number and Signal name

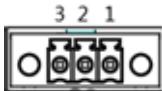
Type	Pin No.	Signal	Direction	Description
	1	D+	IN/OUTPUT	RS-485 Data (+)
	2	D-	IN/OUTPUT	RS-485 Data (-)
	3	SG	-	Signal Ground

* Be sure to connect the RD and SD to the RS-232C communication line by crossing each other with a Twisted Pair Cable. Please connect SG directly.

* RS-422/485 communication line must use RDA and RDB as Twisted Pair Cable, SDA and SDB as Twisted Pair Cable.

* Communication cable's Shield cable cannot be used as communication ground. It can cause communication error.

5.2 Ethernet Interface

5.2.1 Ethernet

Item	Description
Ethernet Method	IEEE802.3i/IEEE802.3u, 10BaseT / 100BaseT
Speed	10M / 100Mbps
Communication Method	Base Band
Switching Method	AUTO MDIX
Maximum Segment Length	100M (between Hub)
Communication Cable	UTP (Unshielded Twisted Pair)
Modular Jack	RJ45 x 2ch

5.2.2 RJ – 45 Pin Layout

Type	Pin No.	Color	Signal
	1	Orange/White	TD+
	2	Orange	TD-
	3	Green/White	RD+
	4	Blue	Not use for 10Base-T
	5	Blue/White	Not use for 10Base-T
	6	Green	RD-
	7	Brown/White	Not use for 10Base-T
	8	Brown	Not use for 10Base-T

* When a HUB is used, be sure to use straight cable to connect.

Ex) Straight Cable Wiring: Connect 1:1 according to the wiring diagram above.

* In case of do not using HUB, do not use HUB, when it is connected directly, Cross Cable should be used.

Ex) Cross Cable Wiring: In the above wiring diagram, TD+ and RD+ are changed, and TD- and RD- are exchanged.

5.3 USB Interface

5.3.1 USB Host

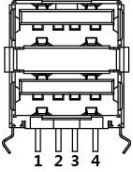
Type	Item	Specification
	USB Interface	EHCI/OHCI Specification Version 1.0, USB2.0/1.1 Compatible
	Communication Method	Control/Bulk
	Transfer Speed	Max. 480Mb/s
	Support Device	USB Storage (FAT16/FAT32 File Format)
	Connector Type	Type A(2ch)

5.3.2 USB OTG

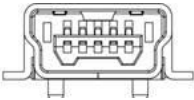
Type	Item	Specification
	USB Interface	USB 2.0
	Communication Method	Interrupt/Bulk/Isochronous
	Transfer Speed	Max 480Mb/s
	Supportive OS	Windows 98SE/2000/XP/VISTA/7/10(32/64bit)
	Cable Length	M2I manufacturer's cable is recommended (3M), and 1.5M or less when purchased separately
	Connector Type	Mini USB B, Female
	Connecting Method	Front, USB OTG connector

Chapter 6 Installation

6.1 Installation Requirements

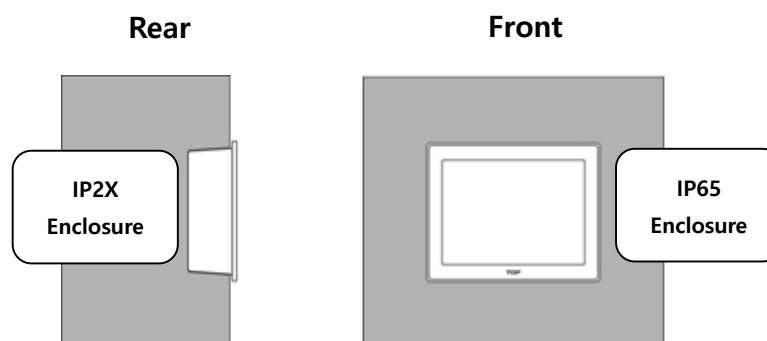

(1) It should be installed within $-10 \sim 50^{\circ}\text{C}$ and 10~80% relative-humidity, otherwise the screen may be changed or cause malfunction and damage.

(2) Be sure that heat from surrounding equipment does not cause product to exceed its standard operating temperature.

(3) In order to minimize external mechanical hazards, please control the mechanical hazards of the surrounding environment.

M2I Corporation

11-35, Simin-daero 327beon-gil, Dongan-gu, Anyang-si, Gyeonggi-do 14055, Korea,

Tel: +82-70-465-3366, Fax: +82-31-465-3355, www.m2i.co.kr

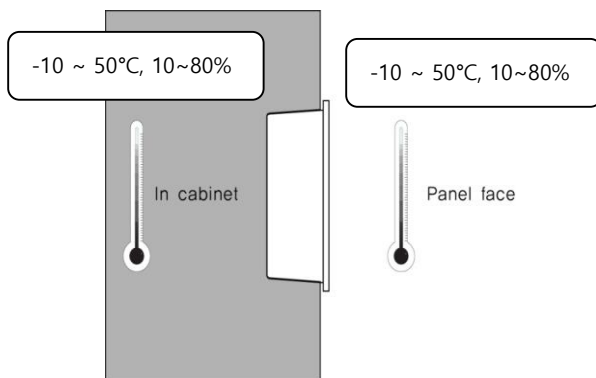

6.2 Install Procedure

Please follow as below explanation to install the product.

6.2.1 Panel Cut-out

Make a panel cut which product is mounted and insert the product to the panel from the front side. Making the Panel Cut (Mounting Size) per each model as below Table, Before Installation.

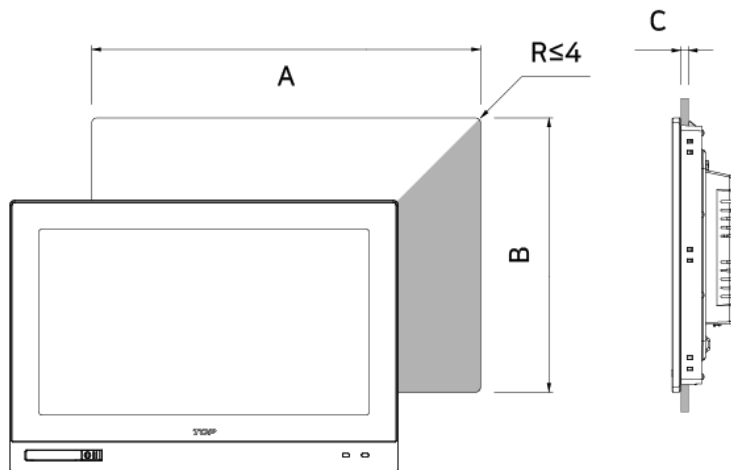

Model	A (mm)	B (mm)	C (mm)
TOPRC1200WD	307(+0.5/0)	238(+0.5/0)	1.6~5.0(+1.0/0)
TOPRC1500WD	392(+0.5/0)	272(+0.5/0)	
TOPRC1900WD	463(+0.5/0)	314(+0.5/0)	

6.2.2 Fixation Warning

Installation methods should be following by using the supplied installation clamps.

(1) Insert the clamp into the slot of the product.

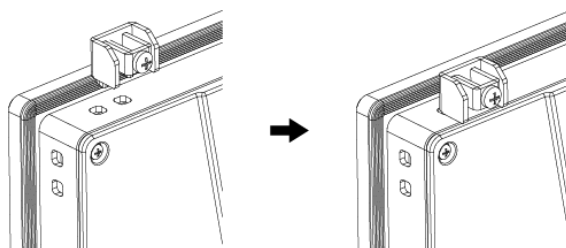

(2) Screw the unit into the panel cut with a screwdriver.

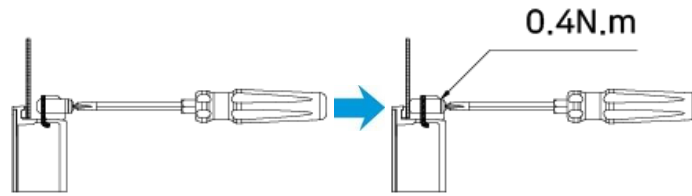

If the clamping screw below is over-tightened, the touch sensor may stop working or malfunction. Tighten to 0.4N.m screwdriver torque.

* Caution: IP performance cannot be secured if the clamp is not tightened with a tightening force of 0.4N.m.

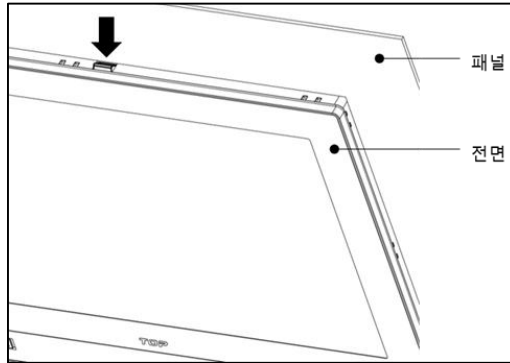

When you detach the product from a panel, please use tools like driver to push a lock part and detaching should be done slowly.

6.3 Front USB

6.3.1 Open / Close of Font USB Cover

- (1) TOPRC□□00: When you open a USB cover, you can connect MINI USB B cable.
- (2) This cover can be locked and unlocked by making rotation of lock rotary switch



6.3.2 Data Upload and Download

You can download or Upload Project file data through USB interface.

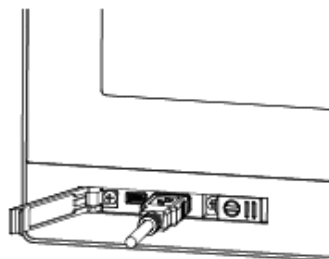

Chapter 7 Wiring Warning

7.1 Power Cable Wiring

(1) The Power cable should have the following specification.

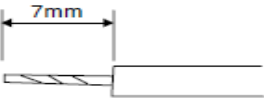
Power Cable Specification	0.75~2.5mm ² (18~12AWG)
F.G Cable Specification	2mm ² (14AWG)
Conductor type	Simple or Stranded wire (use copper conductor only)
Bolt torque	≥ 0.4N.m  Warning
Conductor length	
Temperature rating of the field installed conductors	65°C or under

(2) The Power terminal should have the following specification.

To Prevent wearing of cable and to enhance electronic transmission, please use a pin type conductor for power cable and ground wiring.

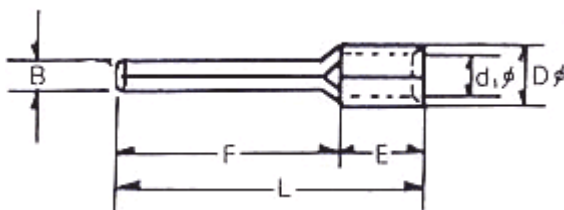

(mm)

B	L	F	E	D	d
1.8~2.0	22~18	12~14	5	3.3~3.8	2~2.5

(3) Wiring of power cable is as follows.  Warning

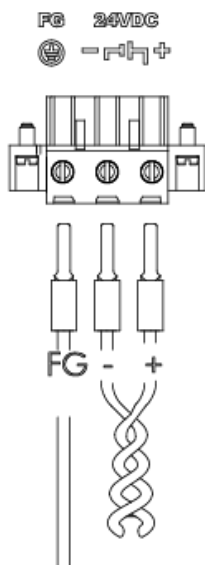

7.2 Ground wiring Warning

- (1) The product has enough anti-noise measure, so except that there are many noises. Specially, the ground is not needed. When doing ground, please refer to the followings.
- (2) The ground should be the exclusive ground.
The ground should be type class 3 ground (ground resistor is less than 100Ω).
- (3) When not doing the exclusive ground, do common ground like figure B).

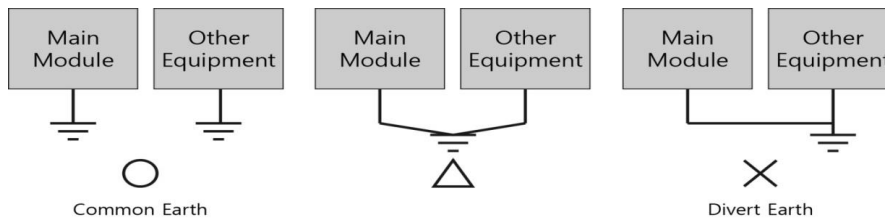

Fig. Grounding Example Diagram

- (4) Use the cable more than 2mm^2 . Put the point of the ground near product and shorten Ground line.

7.3 USB Cable Fixation

Caution: In order to prevent disconnection of USB cable or spark generation, it has to be fixed. Please refer to following contents.

- (1) Belt the USB connector's body by a cable tie before inserting the USB cable loosely.

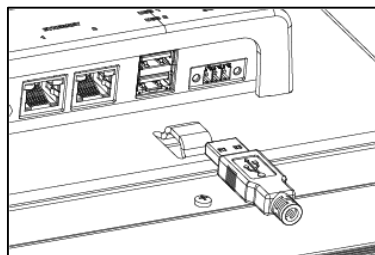

- (2) After insert the USB cable into a port completely, fix the cable by tighten the cable tie to prevent a disconnection.

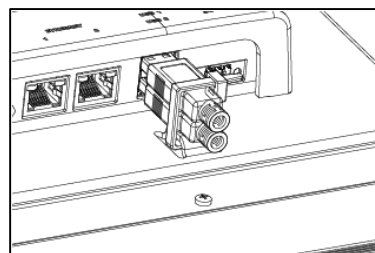

Chapter 8 Maintenance Warning

8.1 Cleaning the Display

When the surface or frame of the display become dirty, spray the cleaning solution onto a soft cloth and wipe

the device. Do not spray the cleaning solution directly onto the device.

8.2 Periodic Check Points

Check the followings periodically for best condition of the device.

(1) Environment

- Is the operating temperature within the allowable range (-10°C~50°C)?
- Is the operating humidity within the allowable range (10%~80%RH)?
- Is the Surrounding pollution no corrosive gas?

(2) Power

- Is the input voltage within the change range?

(3) Related Items

- Check an internal battery when an exchange or voltage drop is displayed.
- Check the guarantee duration of LCD Backlight by eye.
- Check the touch pad there is no damage, scratch or pollution by eye.

8.3 Problems with the Device Warning

- If there is a problem during operation, stop using it and contact the A/S department of M2I Corporation, which is indicated on the product label.
- Only the authorized worker from M2I Corporation can check and repair problems related to malfunction of the machine.
- If the problem cannot be solved at the installation site, the equipment can be collected and moved to M2I Corporation.
- The manufacturer, M2I Corporation, is not responsible for damage or malfunction of the equipment caused by the use conditions of the user beyond the installation and use standards described in the manual.
- If there is a high electromagnetic noise, put ferrite core on main power cable and field cable. The noise of power cable and communication cables can be high under the installation circumstances.
- Please put ferrite cores on each side's end when USB is not working by noise.

8.4 Setting System Recovery Mode

- If the system fails to boot normally due to a problem during operation, the built-in recovery function can be used to maintain the factory default state. Please note that the built-in project will be deleted when using the recovery mode.
- After opening the rear cover, you can adjust the setting switch. Keep the "Normal" state when booting normally. If the system is recovering, turn off the power and set it to "Factory Reset".
- When the recovery is completed, the buzzer sounds, then turn off the power and reset to "Normal" state.

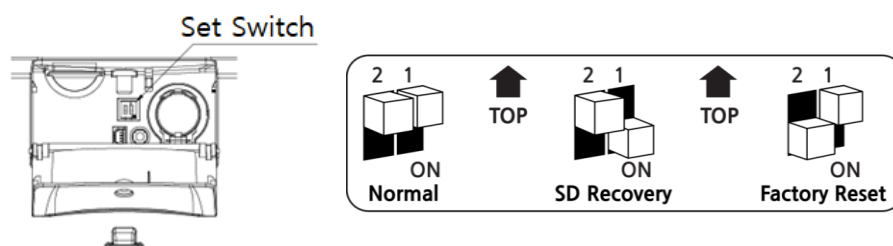

Chapter 9 Products and Warning Label Location

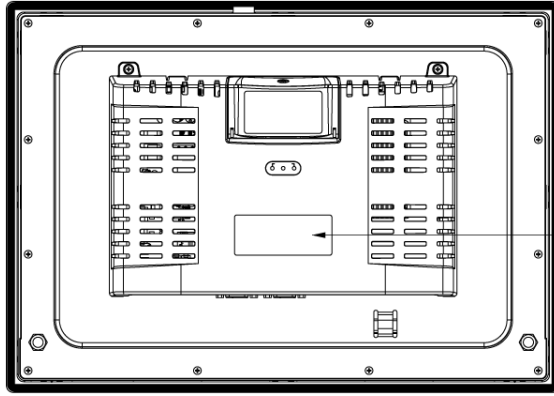

Warning label



Manufacturer(AS): M2I Corporation

11-35, Simin-daero 327beon-gil, Dongan-gu, Anyang-si,
Gyeonggi-do 14055, Korea
Tel: 82-31-465-3366

Product Type: Industrial Touch Panel

Model Name and Power Specifications:

- TOPRC1200WD: 24Vdc, 40W or less, Class 2 Power Only
- TOPRC1500WD: 24Vdc, 40W or less, Class 2 Power Only
- TOPRC1900WD: 24Vdc, 40W or less, Class 2 Power Only

Operation Temperature: $-10^{\circ}\text{C} \leq T_a \leq +50^{\circ}\text{C}$



Copyright: M2I Corporation 2024.05

www.m2i.co.kr

- Please read related contents in this manual when you use M2I product, and operate the product staying safe with appropriate handling.
- This manual should be stored in secured and appointed place so that it can be read in any needs.

User Guide

This product has Relevant Assessments for business environment, it is a wireless device satisfying a Conformity Assessment by the Wireless Telegraphy Act. Paragraph 2 of Article.